

HALFEN HDB PUNCHING SHEAR REINFORCEMENT AND SHEAR REINFORCEMENT Technical Product Information

NEW!

with European Technical Assessment ETA-22/0360
for HDB-Z Punching shear reinforcement for
floor slabs and foundations





We are one team. **We are Leviat.**

Leviat is the new name of CRH's construction accessories companies worldwide.

Under the Leviat brand, we are uniting the expertise, skills and resources of HALFEN and its sister companies to create a world leader in fixing, connecting and anchoring technology.

The products you know and trust, including HALFEN Punching shear reinforcement and Shear reinforcement, will remain an integral part of Leviat's comprehensive brand and product portfolio. As Leviat, we can offer you an extended range of specialist products and services, greater technical expertise, a larger and more agile supply chain and better, faster innovation.

By bringing together CRH's construction accessories family as one global organisation, we are better equipped to meet the needs of our customers, and the demands of construction projects, of any scale, anywhere in the world.

This is an exciting change. Join us on our journey.

Read more about Leviat at [Leviat.com](https://www.leviat.com)



Our product brands include:

Ancon[®]

HALFEN

PLAKA



60
locations

sales in
30+
countries

3000
people worldwide

Imagine. Model. Make.

Leviat.com

Quality and Service which connects

Our un-rivalled, diverse product range provides economical, one-of-a-kind, technical solutions; all from a single source.

Our quality products make us one of the world's leading companies in the fields of concrete, façade and industrial technology.

We are your partner in the design as well as in the construction phase of your project. We are there to provide technical support at every stage of a project, from initial design to final completion.

■ Technical Support

From easy product selection with a simple ordering process to the development of a customized and digitized project-specific design solution.

■ State-of-the-art Calculation software

for calculating and project-design is available for free download from our website.

■ Building component available for BIM

Our products and our engineers' plans are also available as BIM-compatible CAD files to use when creating a 3D model of your project.

■ Knowledge support

We support you and your team with one-on-one product training, and with example applications.

■ Reliable and safe

Installation instructions, type tests, approvals/assessments, certificates and product declarations provide the required reliability for design and realization of all your projects.

If you have any questions about the HALFEN HDB Shear rails or would like information on our cross-brand range of products, please contact your regional Leviat support team.





HALFEN
HDB Shear rail

HALFEN PUNCHING SHEAR REINFORCEMENT AND SHEAR REINFORCEMENT

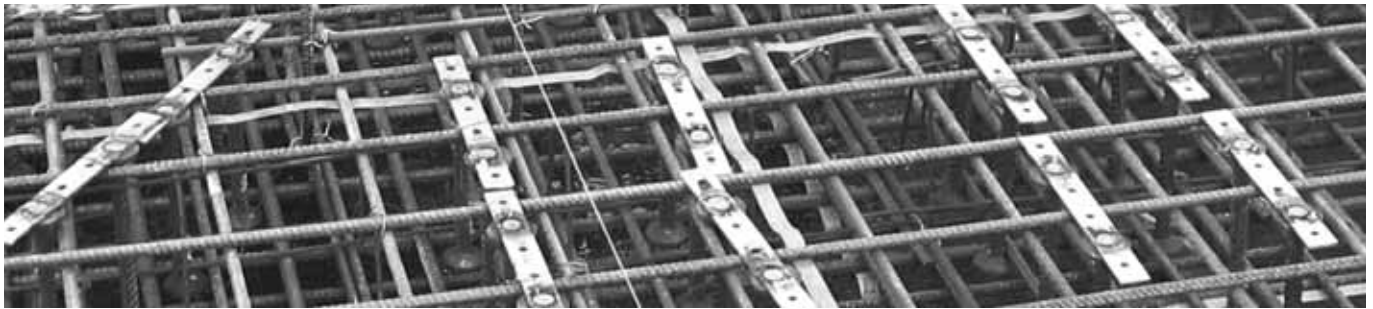
Contents

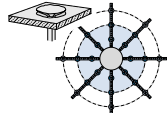
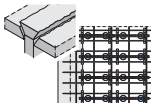

HALFEN HDB Punching shear and shear reinforcement	6-8	
HDB Punching shear reinforcement	7	
HDB-S Shear reinforcement	10	
Product overview	10	
HALFEN HDB as punching shear and shear reinforcement	10	
Calculation: Basic principles	11-16	
Point-load supported slabs	11	
Design concept	12	
Combination of System elements	17	
Combinations of HDB System elements	17	
Installation notes	18-19	
Layout of the punching shear reinforcement	18	
Layout of HDB Elements	19	
Type selection	20-21	
Standard elements	20	
System elements	21	
Simplified calculation	22-23	
Simplified calculation with a FE-calculation software	22	
Installation notes	24	
Allowable anchor spacings	24	
Calculation software HDB / HDB-S	25-27	
Type selection, order information, accessories	28-29	
Order description	28	
Accessories	29	
HDB-F Punching shear reinforcement in element slabs	30-31	
NEW! Now with European Technical Assessment:	32-35	
HDB-Z Punching shear reinforcement for slab and pad foundations		
Tender specification	36	
Contact worldwide	39	

HALFEN HDB SHEAR RAIL – PUNCHING SHEAR REINFORCEMENT

HALFEN HDB – the Economic Solution to Prevent Punching Shear Failure

Situation: point-load supported slabs without enlarged column heads

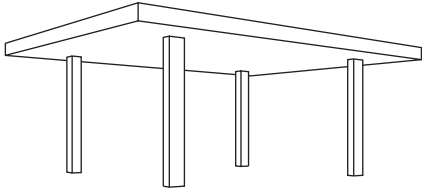

Reinforced concrete slabs with no beams and no enlarged column heads are inexpensive to manufacture. This type of construction results in thinner, lighter and simpler elements, allowing an optimal and flexible use of space.

Particular advantages are:

- low formwork costs
- slimmer, lighter and more aesthetical elements
- easier installation of building utilities under slabs (e.g. pipes or ventilation ducts)
- more flexibility for interior fittings
- floor heights can often be reduced

Problem: punching shear verification around columns

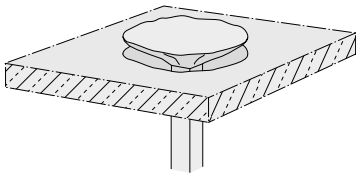

Punching shear of the column head through the concrete slab

Load concentration around the column head generally leads to increased stresses, which cannot be absorbed solely in thin slab thicknesses. Previously, to prevent punching shear

failure, uneconomical and unfavourable solutions were used, e.g. increasing the slab thickness or using enlarged column heads (see illustration).

However, these methods reduce the usable height between floors and therefore limit building space.

Alternatively, stirrups cages may be used as punching shear reinforcement. However installation is complicated as the stirrups must enclose the longitudinal slab reinforcement.

– Uneconomical
Enlargement of the slab at the column head or the whole concrete slab

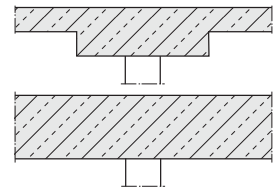

– Uneconomical
Elaborate and costly installation of stirrup reinforcement

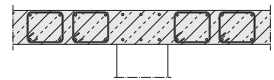

Solution: HALFEN HDB Shear rails

HDB Shear rails consist of double-headed studs with forged heads. The individual studs are welded onto a spacer bar to form a HDB Shear rail. A main advantage of the HDB Shear rail is the positive-form-locking and nearly slippage free anchorage. Tests show that the maximum load

capacity using conventional punching shear reinforcement, e.g. stirrups is restricted. This is due to the greater slippage with stirrups. Large diagonal cracks develop around the column, which ultimately lead to failure. The slippage free anchorage of the HDB Studs means shear cracks are kept

to a minimum. Compared to stirrups this system is therefore more suitable for the higher loads around columns. The diagram illustrates the proven higher punching shear capacity of shear rails when compared to stirrups.

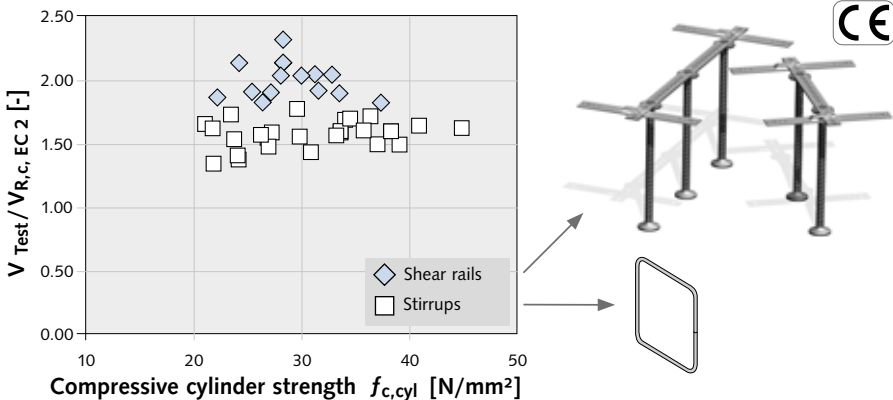

+ Our solution:
Flat ceiling with HDB Shear rails around the column head

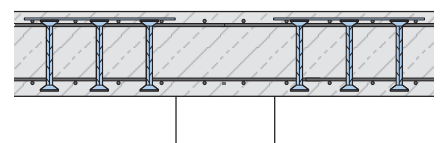

HALFEN HDB SHEAR RAIL – PUNCHING SHEAR REINFORCEMENT

Punching Reinforcement in On-site Cast Slabs

Advantages of HDB Shear rails



⊕ Planning

- higher loads compared to stirrup reinforcement possible
- reduced required reinforcement cross section compared to conventional reinforcement in accordance with Eurocode 2 NA(D) German National Annex
- building authority approved as punching shear reinforcement in slabs, foundation slabs and pad foundations
- HDB Shear rails can also be used in precast elements and semi-precast elements
- also approved for non-predominantly static loads
- standardized product range for typical dimensions
- user-friendly and efficient software

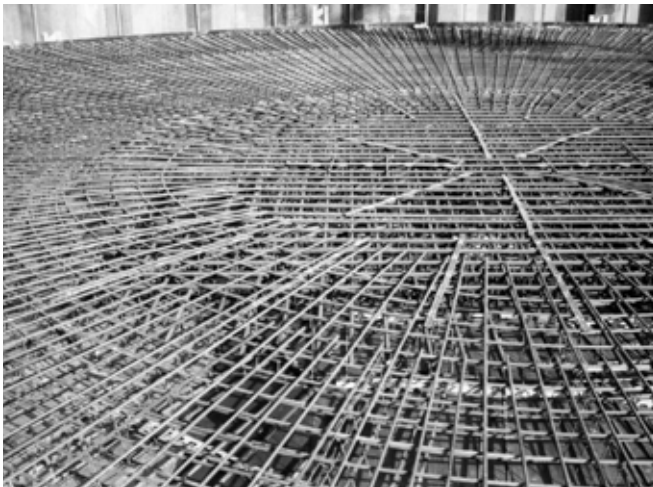

⊕ Safety

- European-wide building authority approved by the (DIBt) German Institute of Construction Engineering in Berlin
- simple visual control of installed elements
- negligible slippage of anchorage in the shear reinforcement
- correct concrete cover ensured with matching accessories (spacers and clamps)



⊕ Installation

- simple and quick installation
- reduced build-time
- longitudinal reinforcement does not need to be wired to the shear reinforcement
- installed after placing the main upper and lower longitudinal reinforcement
- reduction of the required punching shear reinforcement elements with larger allowable anchor spacings in comparison to stirrup reinforcement and with larger allowable tangential stud spacing according to the German National Annex NA(D) to EN 1992-1-1:2011-01 (Eurocode 2)

HALFEN HDB-S SHEAR RAIL — SHEAR REINFORCEMENT

Shear Load Reinforcement in On-site Cast Slabs

The situation: linear supported slabs — verification of shear load capacity

According to EN 1992-1-1:2011-01 (Eurocode 2) shear load capacity for reinforced concrete precast slabs must be verified in all shear cross-sections. In Germany, the regulations according to the German National Annex NA(D) must also be observed.

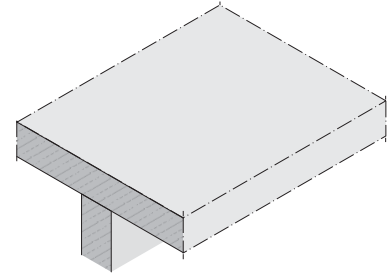
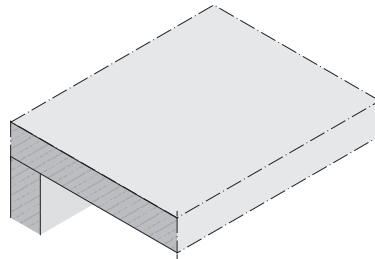

The challenge: Shear failure in the support area

Shear forces in the support area of linear supported slabs may cause a brittle shear failure. To avoid shear failure, slab thickness may be increased or shear reinforcement may be installed. However in most cases geometric conditions allow only for installation of shear reinforcement.

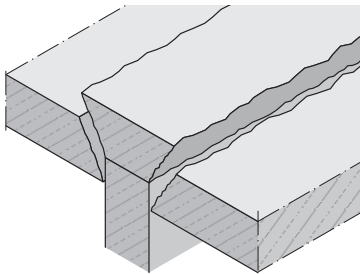

According to the German National Annex NA(D) for EN 1992-1-1:2011-01, at least 50 % of expected shear force in high-load slabs ($V_{Ed} > \frac{1}{3} \times V_{Rd,max}$) require stirrup reinforcement, which must enclose the longitudinal reinforcement in the compression zone.

Fitting stirrup reinforcement is very demanding as stirrup bending needs to be finalized during installation. This method is not just time-consuming but also inaccurate, often resulting in inadequate concrete cover for the stirrups.

— **Uneconomical**
Increasing the slab thickness

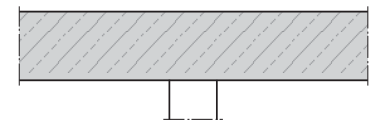

— **Uneconomical**
Time consuming installation of stirrup cage reinforcement

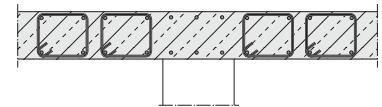

The solution: HALFEN HDB-S Shear rails

HDB-S Shear rails are made of double-headed, forged head anchors. An assembly bar tack-welded to the anchor heads connects the individual anchors to form a HDB-S Shear rail. HDB-S Shear rails are preferably placed from above after the main reinforcement has been installed. Placing the individual elements end to end, in rows, allows large areas to be reinforced quickly and efficiently.

A further advantage is the negligible slippage in the concrete, guaranteed by the effective bond of the forged head. This gives the shear reinforcement better anchorage, especially in thin slabs. With HDB-S Anchors the shear reinforcement cross-section is reduced.

+ **Our solution:**
Support with HDB-S Shear reinforcement

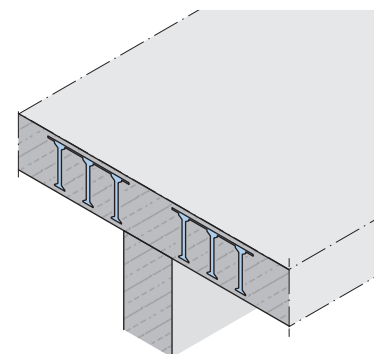

HALFEN HDB-S SHEAR RAIL — SHEAR REINFORCEMENT

Shear Load Reinforcement in On-site Cast Slabs

Advantages of the HDB-S Shear rails



⊕ Planning

- as much as 20 % lower reinforcement cross section compared to conventional stirrup reinforcement according to Eurocode 2 with NA(D) German National Annex
- building authority approved for building elements subjected to shear load, for example, wall elements, beams, precast and semi-precast elements
- also approved for non-predominantly static loads
- standardized product range for typical dimensions
- efficient and user friendly software



⊕ Safety

- approved by the DIBt, German Institute of Construction Engineering
- simple visual control of installed elements
- negligible slippage of anchorage in the shear reinforcement
- correct concrete cover is ensured when using suitable accessories (spacers and clamps)



⊕ Installation

- simple and quick installation
- reduced build-time
- longitudinal reinforcement does not need to be tied to the shear reinforcement
- installed after placing the main upper and lower longitudinal reinforcement
- reduction of the required shear load reinforcement elements with larger allowable anchor spacings in comparison to stirrup reinforcement according to the German National Annex NA(D) to EN 1992-1-1:2011-01 (Eurocode 2)

HALFEN PUNCHING SHEAR REINFORCEMENT / SHEAR REINFORCEMENT

Overview

HALFEN HDB as punching shear reinforcement and shear reinforcement

Double-headed stud

Made of reinforcing steel B 500 (smooth or ribbed)
supplied in diameter d_A :
10 - 12 - 14 - 16 - 20 - 25 mm

The stud head diameter is 3 times the bar diameter d_A :

$$d_K = 3 \cdot d_A$$

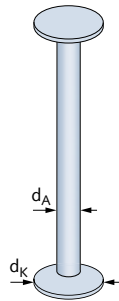

HDB/HDB-S Elements

The double-headed studs are connected using a welded-on spacer bar. Clip bars are used to secure the spacer bar to the reinforcement. Clip bars can be attached anywhere on the spacer bar. (order separately, see page 29).

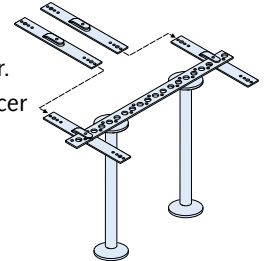

Design variants

HDB/HDB-S System elements:

- available as 2- and 3-stud elements, can be placed in rows
- standard elements, with short delivery time

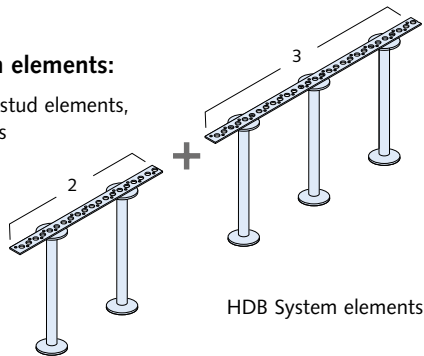

HDB System elements

HDB/HDB-S Complete elements

- with 2 - 10 studs on one spacer bar

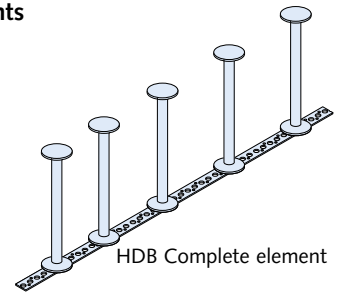

HDB Complete element

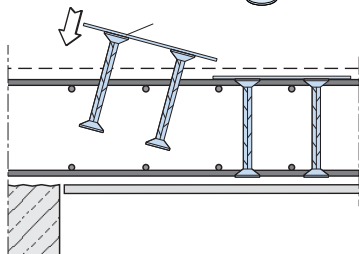

Symmetrical HDB System elements are preferably installed from above after installing the main reinforcement.

Installation in in-situ cast concrete slabs

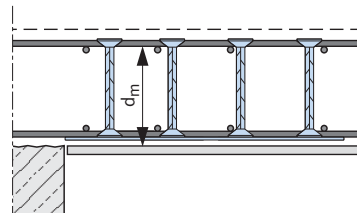

HDB Complete elements are preferably installed from below before placing the main reinforcement.

HDB-F Complete elements (for precast plants)

- with 2 or up to 8 anchors on one spacer bar
- with temporary fixing for semi-precast elements

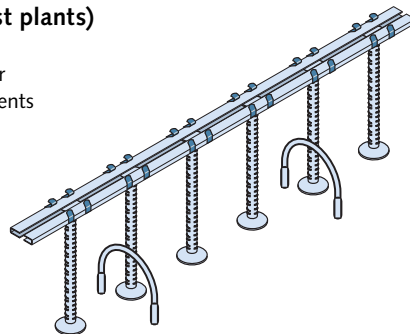

Installation in semi-precast element:

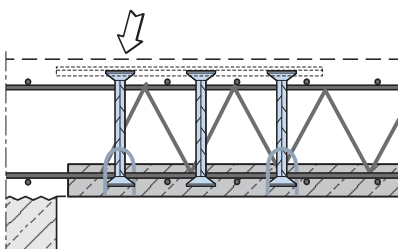

Can also be installed from above in semi-precast slabs: HDB-F Shear rail with detachable spacer bar and welded spacers (see page 30).

HALFEN PUNCHING SHEAR REINFORCEMENT

Calculation: Basic Principles

Point-load supported slabs

Design concept according to EN 1992-1-1:2011-01 (Eurocode 2)

The European standard EN 1992-1-1:2011-01 specifies the maximum punching shear capacity for flat slabs analogically to the strength of the compression strut of beams. However, test evaluations prove that this method is not applicable for flat slabs. Particularly in tests using stirrups as punching shear reinforcement, the level of safety required by EN 1990:2010-12 was not achieved, (see diagram a).

This is why an improved design concept based on current punching shear tests was derived for the HDB Punching shear reinforcement. The new concept is included in European Technical Assessment ETA-12/0454 (HDB).

When using this calculation method, the required level of safety is reached; as shown in the evaluation of the tests using double-headed anchors (compare diagram b).

European Technical Assessments are issued by the (DIBt) German Institute of Construction Engineering. ETA-12/0454 regulates design basics for HDB Shear rails.

Deviating from the Eurocode 2 definition, the maximum load capacity was defined as a multiple of the load capacity without punching shear reinforcement. This means the maximum allowable shear stress $v_{Rd,max}$ is checked along the critical perimeter at a distance of $2.0d$ from the edge of the load application area. For HDB Shear rails, maximum allowable shear stress must be limited to $1.96 v_{Rd,c}$. Here $v_{Rd,c}$ is the punching shear resistance without punching shear reinforcement in accordance with Eurocode 2 with the respective applicable national annex.

a) Stirrups according to EN 1992-1-1:2011-01 without NA(D)

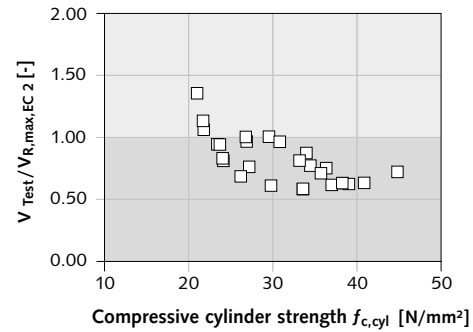

b) HDB Shear rails – HDB approval ETA-12/0454

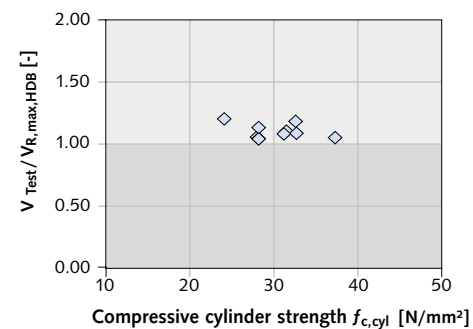

HALFEN PUNCHING SHEAR REINFORCEMENT

Calculation: Basic Principles

Design concept

1. Design concept and actual stresses

$$\text{Design requirement: } \beta \times V_{Ed} \leq V_{Rd}$$

The following constant load factors can be used when calculating the crucial shear force $\beta \times V_{Ed}$ in accordance with ETA -12/0454 (HDB Shear rails)

$$\begin{aligned} \beta &= 1.10 && \text{for inner columns (NA(D))} \\ \beta &= 1.15 && \text{for inner columns (EN 1992-1-1)} \\ \beta &= 1.40 && \text{for edge columns} \\ \beta &= 1.50 && \text{for corner columns} \end{aligned}$$

For a quick approximation the following generic, simplified load factors may also be used for wall ends and wall corners:

$$\begin{aligned} \beta &= 1.35 && \text{for wall ends} \\ \beta &= 1.20 && \text{for wall corners} \end{aligned}$$

The more precise method of assuming plastic shear distribution than with EN 1992-1-1:2011-01 can be used as an alternative or as soon as the span width of adjoining slabs deviate more than 25% from each another.

2. Verification of punching shear capacity without punching shear reinforcement

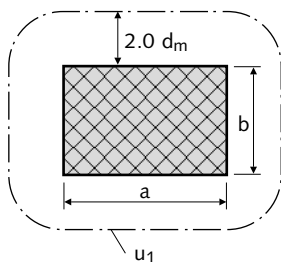

$$u_1 = 2(a + b) + 2 \cdot \pi \cdot 2.0 d_m$$

with: $b \leq a \leq 2b$
and $(a + b) \cdot 2 \leq 12 d_m$
 d_m = mean effective static depth

Design value for effective shear stress along the critical perimeter:

$$v_{Ed} = \frac{\beta \cdot V_{Ed}}{u_1 \cdot d_m} \quad [\text{N/mm}^2]$$

with: β = load increase factor
 V_{Ed} = design value of effective shear force
 u_1 = length of the critical perimeter

Design resistance for slabs without punching shear reinforcement:

$$v_{Rd,c} = C_{Rd,c} \cdot k \cdot (100 \cdot \rho_l \cdot f_{ck})^{1/3} \quad [\text{N/mm}^2]$$

The empirical pre-factor $C_{Rd,c}$ is dependent on the respective column perimeter u_0 / d_m and is defined as follows:

$$\begin{aligned} u_0 / d_m \geq 4 : C_{Rd,c} &= \frac{0.18}{\gamma_C} \\ u_0 / d_m < 4 : C_{Rd,c} &= \frac{0.18}{\gamma_C} \left(0.1 \cdot \frac{u_0}{d_m} + 0.6 \right) \geq \frac{0.15}{\gamma_C} \end{aligned}$$

$\gamma_C = 1.5$: partial safety factor for concrete

u_0 = column perimeter

$k = 1 + \sqrt{200/d_m} \leq 2.0$ (Enter scaling factor for influence of the component height in [mm])

$$\rho_l = \sqrt{\rho_{lx} \cdot \rho_{ly}} \leq \begin{cases} 0.02 \\ 0.5 \cdot f_{cd} / f_{yd} \end{cases}$$

(Longitudinal reinforcement ratio in the area of the column width plus $3d_m$ each side, compare with point 7, page 15)

f_{ck} = characteristic concrete compressive strength [N/mm²]

f_{cd} = design value for concrete compressive strength [N/mm²]

f_{yd} = design yield strength for reinforcement steel [N/mm²]

Verification: $v_{Ed} \leq v_{Rd,c} \Rightarrow$ no punching shear reinforcement necessary
 $v_{Ed} > v_{Rd,c} \Rightarrow$ punching shear reinforcement necessary

HALFEN PUNCHING SHEAR REINFORCEMENT

Calculation: Basic Principles

3. Verification of maximum punching shear capacity

Verification:

$$V_{Ed} \leq v_{Rd,max}$$

For flat slabs:

$$\text{HDB Shear rails } v_{Rd,max} = 1.96 v_{Rd,c}$$

Calculated resistance along the outermost control perimeter:

$$v_{Rd,c,out} = \frac{0.15}{\gamma_c} \cdot k \cdot (100 \cdot \rho_l \cdot f_{ck})^{1/3} \text{ [N/mm}^2\text{]}$$

4. Verification outside of the punching shear reinforcement area

Proof:

$$V_{Ed} \leq v_{Rd,c,out} \Rightarrow \text{calculation of } l_{s,req}$$

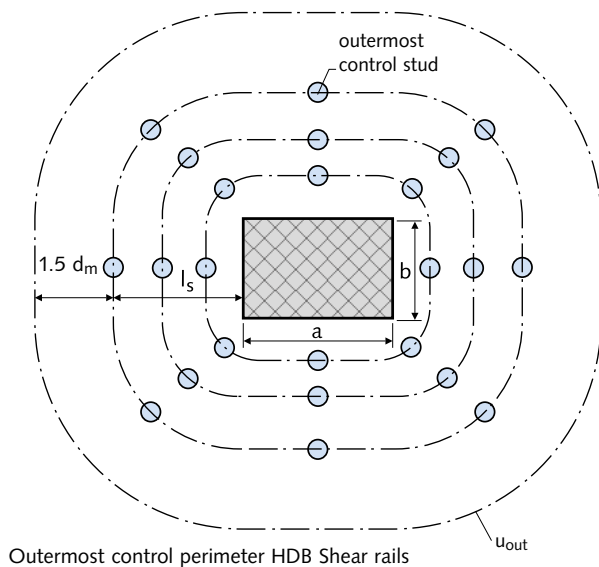

$$u_{out} = 2 \cdot (a + b) + 2\pi \cdot (l_s + 1.5 d_m)$$

with l_s = distance of the outermost control HDB Anchor

Design value for effective shear stress along the outermost control perimeter:

$$v_{Ed,out} = \frac{\beta_{red} \cdot V_{Ed}}{u_{out} \cdot d_m} \text{ [N/mm}^2\text{]}$$

with $\beta_{red} = \kappa_\beta \cdot \beta \geq 1.1$

(e.g. for inner columns, $\kappa_\beta = 1.0$)



κ_β -values for edge and corner columns can be found in ETA-12/0454.

HALFEN PUNCHING SHEAR REINFORCEMENT

Calculation: Basic Principles

5. Calculating the required punching shear reinforcement

5.1 HDB Shear rails

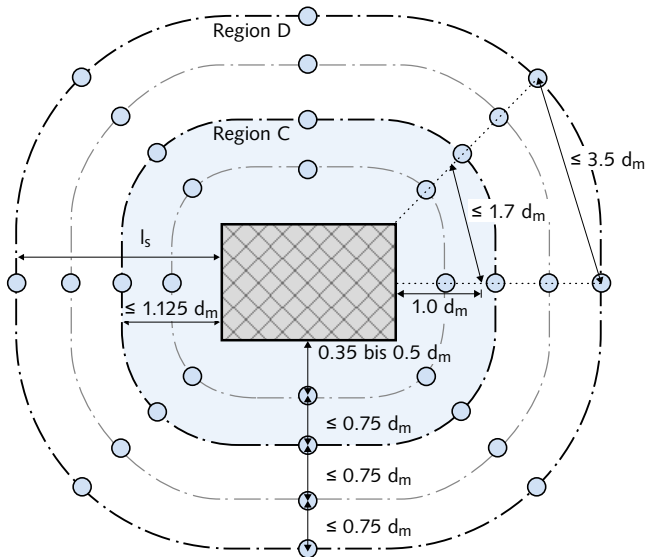

Required punching shear reinforcement in region C

$$A_{s,req} = V_{Ed} \cdot \beta \cdot \eta / f_{yd}$$

with: β = load increase factor

$\eta = 1.0$ for $d_m \leq 200$ mm and 1.6 for $d_m \geq 800$ mm
(interpolate for intermediate values)

Required number of studs $n_{C,total}$ in region C

$$req \ n_{C,total} = A_{s,req} / A_{anchor}$$

with A_{anchor} = cross section of one anchor

Stud layout:

The number of element rows is derived from the geometrical requirements for tangential stud spacing according to the assessment (annex 10, 11 of the ETA-12/0454).

The number of anchors required for region C is calculated according to the assessment. See spacing rule for the radial direction. In region C, at least two studs of equal diameter must be used in each element row.

Verification:

$$V_{Rd,sy} = m_C \cdot n_C \cdot A_{anchor} \cdot f_{yd} / \eta \geq V_{Ed} \cdot \beta \quad [\text{kN}]$$

6. Regulations for spacings

6.1 HDB Shear rails

Apart from the static relevant boundary conditions, further geometric specifications have to be observed when placing studs and elements:

- the distance of the first stud from the column edge must be between $0.35 d_m$ and $0.50 d_m$
- maximum studs spacing in radial direction must be $\leq 0.75 d_m$
- maximum tangential anchors spacing at a distance of $1.0 d_m$ from the column edge must be $\leq 1.7 d_m$
- maximum tangential anchor spacing in region D must be $\leq 3.5 d_m$

For thick slabs ($d_m > 50$ cm) with column diameter $c < 50$ cm with increased load ($V_{Ed} > 0.85 V_{Rd,max}$) at least three studs are to be placed in region C.

The element rows required in region C are to be continued up to the edge of the shear reinforced zone while observing the spacing rules for the section. If necessary, to ensure the tangential spacing required in section D, additional rows of elements must be evenly distributed between the rows continuing out of region C.

In addition, the following applies for the radial spacing s_D in region D:

$$s_D = \frac{3 \cdot d_m}{2 \cdot n_C} \cdot \frac{m_D}{m_C} \leq 0.75 d_m$$

where:

m_D = number of element rows in region D

m_C = number of element rows in region C

n_C = number of anchors in one element row in region C

HALFEN PUNCHING SHEAR REINFORCEMENT

Calculation: Basic Principles

7. Reinforcement ratio

When calculating punching shear, the mean value in the outer perimeter is used as the average ratio of reinforcement. The zone must be at least as wide as the column width with an additional 2-times $3.0 d_m$ in all directions.

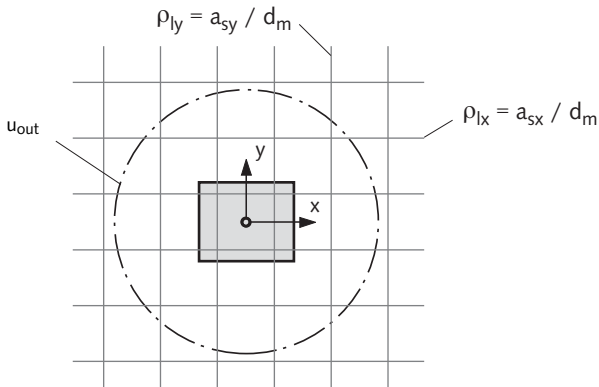

$$\rho_l = \sqrt{\rho_{lx} \cdot \rho_{ly}} \leq \begin{cases} 0.02 \\ 0.5 \cdot f_{cd} / f_{yd} \end{cases}$$

a_{sx}, a_{sy} present flexural reinforcement for each metre in x and y direction
 d_m mean effective static depth

8. Allowing for voids and openings

Voids and openings with at least one edge less than $6 d_m$ away from the load area have to be taken into account when determining the critical perimeter and further perimeters. The section of the critical perimeter within the angle of the opening is to be considered as ineffective.

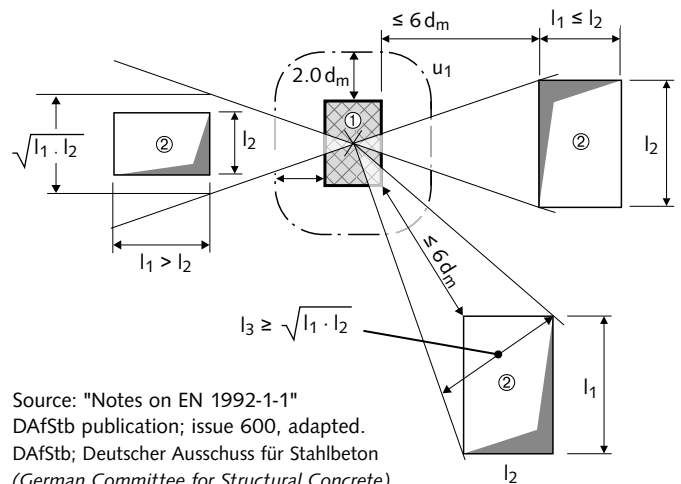

Source: "Notes on EN 1992-1-1"
 DAFStb publication; issue 600, adapted.
 DAFStb; Deutscher Ausschuss für Stahlbeton
 (German Committee for Structural Concrete)

Critical perimeter near to openings

Note:

- ① Load application surface A_{load}
- ② Opening

Minimum bar lengths

HDB Shear rails

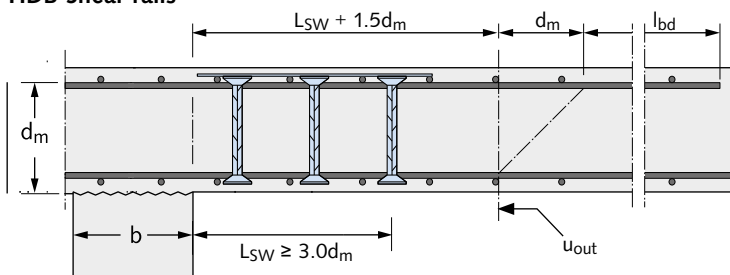

Minimum bar lengths—example for interior column

bar length l_{bar} = $b + 2 \cdot (L_{SW} + 1.5 d_m + d_m + l_{bd})$
 $\geq b + 2 \cdot (3 d_m + l_{bd})$
 l_{bd} = anchorage length according to
 EN 1992-1-1:2011-01 and
 applicable national annex

HALFEN PUNCHING SHEAR REINFORCEMENT

Calculation: Basic Principles

9. Case 1–10

- **Case 1:**
Rectangular internal column

with: $b \leq a \leq 2b$
and $(a + b) \cdot 2 \leq 12 d_m$

d_m = mean effective static depth
Recommended load factor $\beta = 1.10$

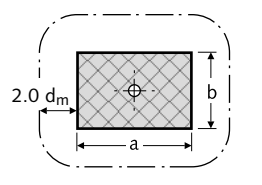

- **Case 6:**
Circular edge column

Recommended load factor $\beta = 1.4$

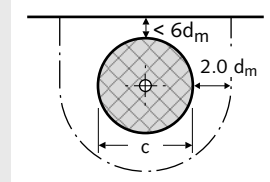

- **Case 2:**
Rectangular edge column
Edge parallel to a

with: $b \leq a \leq 2b$
and $(a + b) \cdot 2 \leq 12 d_m$

Recommended load factor $\beta = 1.4$

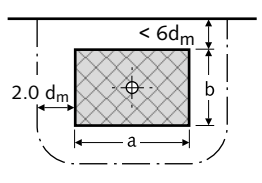

- **Case 7:**
Circular corner column

Recommended load factor $\beta = 1.5$

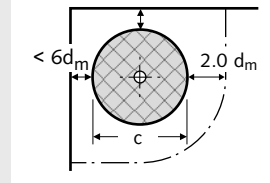

- **Case 3:**
Rectangular edge column
Edge parallel to b

with: $b \leq a \leq 2b$
and $(a + b) \cdot 2 \leq 12 d_m$

Recommended load factor $\beta = 1.4$

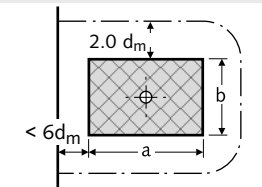

- **Case 8:**
Wall corner

Recommended load factor $\beta = 1.2$

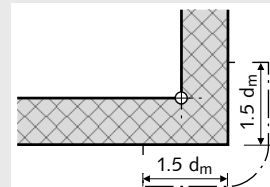

- **Case 4:**
Rectangular corner column
Edge parallel to a and b

with: $b \leq a \leq 2b$
and $(a + b) \cdot 2 \leq 12 d_m$

Recommended load factor $\beta = 1.5$

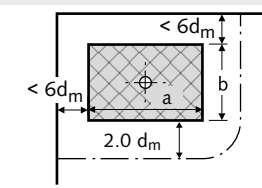

- **Case 9:**
Wall end

Recommended load factor $\beta = 1.35$

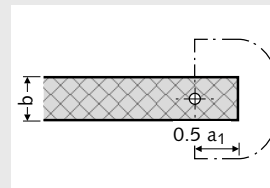

$$a_1 = \min(2b ; 6 d_m - b)$$

- **Case 5:**
Circular inner column

Recommended load factor $\beta = 1.10$

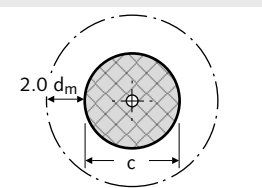

- **Case 10:**
Oval inner column

with: $b \leq 3.5 d$
and $b \leq a \leq 2 b$

Recommended load factor $\beta = 1.10$

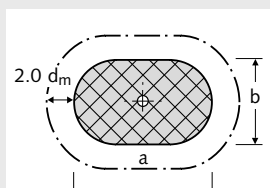

HALFEN HDB SHEAR RAIL — PUNCHING SHEAR REINFORCEMENT

Combination of System Elements

Combinations of HDB System elements

HDB Shear rails in a shear reinforced slab is preferably a combination of 2 and 3 stud system elements. This makes on-site installation easier.

In thick slabs, for example, foundation slabs and where high ratios of reinforcement steel are used, it is recommended to install the HDB Complete elements first, using the bottom-up method.

Table: values l_s for HDB Element combinations

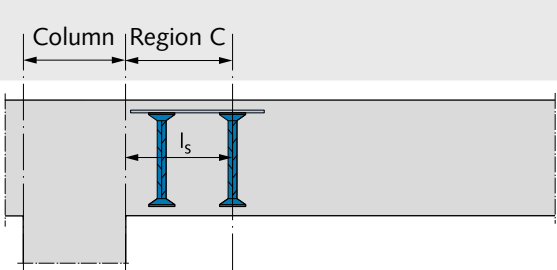
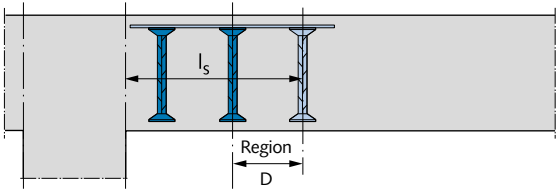
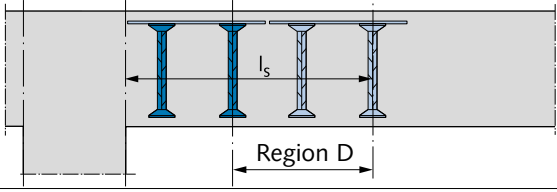
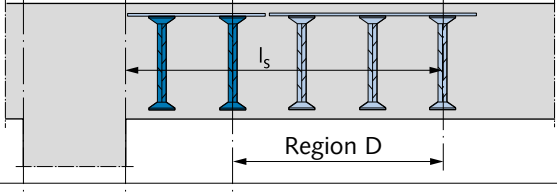
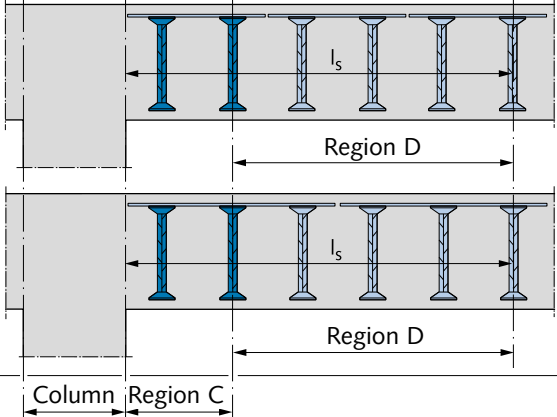
For $l_{s,req}$ (req. l_s) compare to page 13	Available 2- and 3-stud system HDB Combination elements	$l_{s,actual}$	Number of anchors in each HDB combination
$l_{s,req} \leq \sim 1.125 \cdot d_m$	2-stud 	$l_{s,actual} \approx 1.05 \cdot d_m$	2
$l_{s,req} \begin{cases} > 1.125 \cdot d_m \\ \leq \sim 1.875 \cdot d_m \end{cases}$	3-stud 	$l_{s,actual} \approx 1.75 \cdot d_m$	3
$l_{s,req} \begin{cases} > 1.875 \cdot d_m \\ \leq \sim 2.5 \cdot d_m \end{cases}$	2 + 2 studs 	$l_{s,actual} \approx 2.45 \cdot d_m$	4
$l_{s,req} \begin{cases} > 2.5 \cdot d_m \\ \leq \sim 3.2 \cdot d_m \end{cases}$	2 + 3 studs 	$l_{s,actual} \approx 3.15 \cdot d_m$	5
$l_{s,req} \begin{cases} > 3.2 \cdot d_m \\ \leq \sim 4.0 \cdot d_m \end{cases}$	2 + 2 + 2 studs or 3 + 3 studs 	$l_{s,actual} \approx 3.85 \cdot d_m$	6

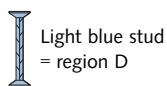
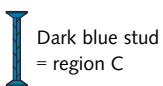

Stud layout
 $L_A \approx 0.7 \cdot d_m$
 $L_{\ddot{u}} \approx 0.35 \cdot d_m = L_A/2$

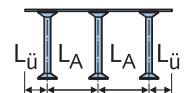

HALFEN HDB SHEAR RAIL – PUNCHING SHEAR REINFORCEMENT

Installation Notes

Layout of the punching shear reinforcement



Note

The simultaneous use of ribbed and smooth studs for the same column is not permitted!

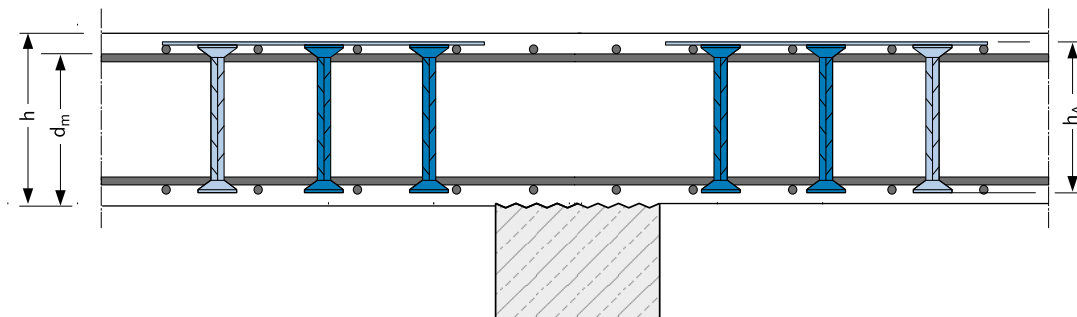
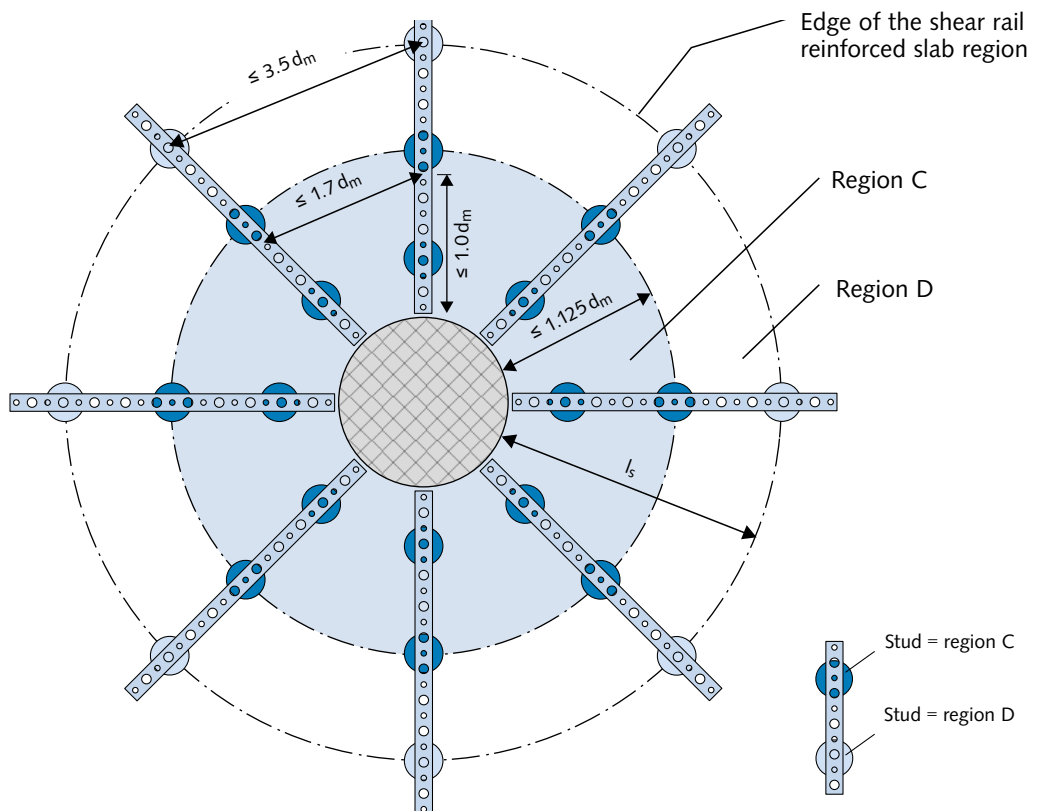

HALFEN HDB SHEAR DOWELS – PUNCHING SHEAR REINFORCEMENT



Installation Notes HDB – According to Column Geometry

Layout of HDB Elements

Depending on the proximity of the columns to the slab edges and the geometric shape of the columns, different HDB Shear rails layouts are necessary.



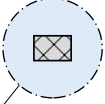
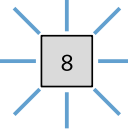
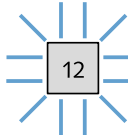
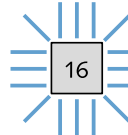
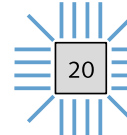
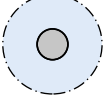
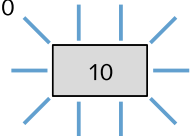
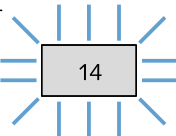
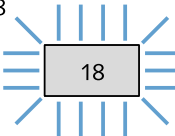
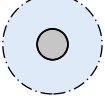
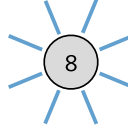
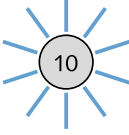
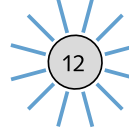
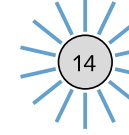
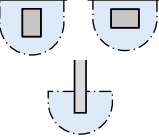
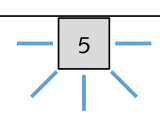
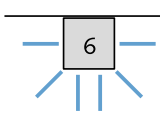
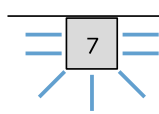
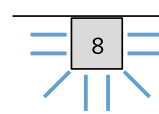
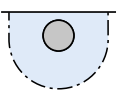
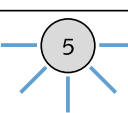
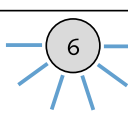
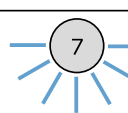
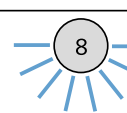
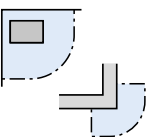
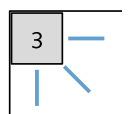
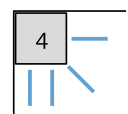
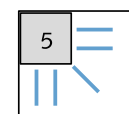

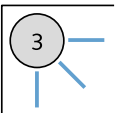
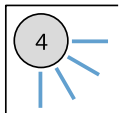
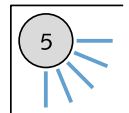



Even if only a few HDB Elements are mathematically required for a low load, additional punching shear elements may be necessary to meet the mandatory maximum space requirements between the studs (see also page 14).

Table: Standard element combinations

 <p>Edge of the shear reinforced slab region</p>	<p>A 8</p> 	<p>A 12</p> 	<p>A 16</p> 	<p>A 20</p> 
	<p>B 10</p> 	<p>B 14</p> 	<p>B 18</p> 	
	<p>C 8</p> 	<p>C 10</p> 	<p>C 12</p> 	<p>C 14</p> 
	<p>D 5</p> 	<p>D 6</p> 	<p>D 7</p> 	<p>D 8</p> 
	<p>E 5</p> 	<p>E 6</p> 	<p>E 7</p> 	<p>E 8</p> 
	<p>F 3</p> 	<p>F 4</p> 	<p>F 5</p> 	
	<p>G 3</p> 	<p>G 4</p> 	<p>G 5</p> 	

HALFEN HDB-S SHEAR RAIL — SHEAR REINFORCEMENT

Type Selection Standard Elements

Anchor cross-section for each element row $a_{sw,HDB-S}$ [cm ² /m]									
Stud spacing $s_{L,HDB}$ [mm]	Element length L_E [mm]		Stud diameter d_A [mm]						studs/m
	2-stud	3-stud	10	12	14	16	20	25	
									
60	120	180	13.12						16.7
65	130	195	12.10						15.4
70	140	210	11.23						14.3
75	150	225	10.45	15.04					13.3
80	160	240	9.82	14.14					12.5
85	170	255	9.27	13.35	18.16				11.8
90	180	270	8.72	12.55	17.09				11.1
95	190	285	8.25	11.88	16.16				10.5
100	200	300	7.85	11.31	15.39	20.11			10.0
105	210	315	7.46	10.74	14.62	19.10			9.5
110	220	330	7.15	10.29	14.01	18.30			9.1
115	230	345	6.83	9.84	13.39	17.49			8.7
120	240	360	6.52	9.39	12.78	16.69	26.08		8.3
125	250	375	6.28	9.05	12.32	16.08	25.13		8.0
130	260	390	6.05	8.71	11.85	15.48	24.19		7.7
135	270	405	5.81	8.37	11.39	14.88	23.25		7.4
140	280	420	5.58	8.03	10.93	14.28	22.31		7.1
145	290	435	5.42	7.80	10.62	13.87	21.68		6.9
150	300	450	5.26	7.58	10.31	13.47	21.05	32.89	6.7
155	310	465	5.11	7.35	10.01	13.07	20.42	31.91	6.5
160	320	480	4.95	7.13	9.70	12.67	19.79	30.93	6.3
165	330	495	4.79	6.90	9.39	12.26	19.16	29.94	6.1
170	340	510	4.63	6.67	9.08	11.86	18.54	28.96	5.9
175	350	525	4.48	6.45	8.77	11.46	17.91	27.98	5.7
180	360	540	4.40	6.33	8.62	11.26	17.59	27.49	5.6
185	370	555	4.24	6.11	8.31	10.86	16.96	26.51	5.4
190	380	570	4.16	5.99	8.16	10.66	16.65	26.02	5.3
195	390	585	4.01	5.77	7.85	10.25	16.02	25.03	5.1
200	400	600	3.93	5.65	7.70	10.05	15.71	24.54	5.0
205	410	615	3.85	5.54	7.54	9.85	15.39	24.05	4.9
210	420	630	3.77	5.43	7.39	9.65	15.08	23.56	4.8
215	430	645	3.69	5.32	7.24	9.45	14.77	23.07	4.7
220	440	660	3.53	5.09	6.93	9.05	14.14	22.09	4.5
225	450	675	3.46	4.98	6.77	8.85	13.82	21.60	4.4
230	460	690	3.38	4.86	6.62	8.65	13.51	21.11	4.3
235	470	705	3.38	4.86	6.62	8.65	13.51	21.11	4.3
240	480	720	3.30	4.75	6.47	8.44	13.19	20.62	4.2
245	490	735	3.22	4.64	6.31	8.24	12.88	20.13	4.1
250	500	750	3.14	4.52	6.16	8.04	12.57	19.63	4.0

stud spacing $s_{L,HDB-S} < 6 d_s!$

HALFEN HDB / HDB-S SHEAR RAIL — PUNCHING SHEAR / SHEAR REINFORCEMENT

Type Selection System Elements

HDB Element lengths L with stud diameter d_A [mm]

$\varnothing d_A$ (a)	$\varnothing 10$		$\varnothing 12$		$\varnothing 14$		$\varnothing 16$		$\varnothing 20$		$\varnothing 25$		stud spacing L_A [mm]
	2 II	3 III	2 II	3 III	2 II	3 III	2 II	3 III	2 II	3 III	2 II	3 III	
Stud height h_A (b) [mm] ②													
105	#	#	-	-	-	-	-	-	-	-	-	-	80
115	#	#	-	-	-	-	-	-	-	-	-	-	80
125	#	#	#	#	#	#	-	-	-	-	-	-	100
135	200	300	#	#	#	#	-	-	-	-	-	-	100
145	200	300	#	#	#	#	-	-	-	-	-	-	100
155	220	330	220	330	#	#	#	#	-	-	-	-	110
165	240	360	240	360	#	#	#	#	-	-	-	-	120
175	240	360	240	360	#	#	#	#	-	-	-	-	120
185	280	420	280	420	280	420	#	#	#	#	-	-	140
195	280	420	280	420	280	420	#	#	#	#	-	-	140
205	280	420	280	420	280	420	280	420	#	#	-	-	140
215	300	450	300	450	300	450	300	450	#	#	-	-	150
225	#	#	320	#	320	480	320	#	#	#	-	-	160
235	#	#	340	510	340	510	340	510	340	510	#	#	170
245	#	#	360	540	360	540	360	540	360	540	#	#	180
255	#	#	#	#	360	540	360	540	360	540	#	#	180
265			#	#	#	#	#	#	#	#	#	#	200
275			#	#	#	#	400	600	400	#	#	#	200
285			#	#	420	630	420	630	420	630	#	#	210
295			#	#	#	#	440	#	440	660	#	#	220
305			#	#	#	#	#	#	440	660	#	#	220
315			#	#	#	#	#	#	#	#	#	#	240
325					#	#	#	#	#	#	#	#	240
335							#	#	480	#	#	#	240
345			#	#	#	#	#	#	#	#	#	#	260
355							#	#	520	#	#	#	260
365					#	#	#	#	#	#	#	#	270
375									#	#	#	#	280
395									#	#	#	#	300
405									#	#	#	#	300
425									#	#	#	#	320
435									#	#	#	#	320
455									#	#	#	#	320

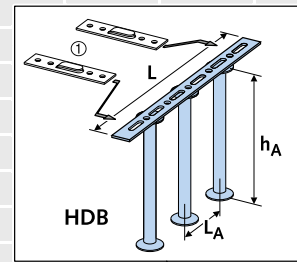

Note: Other element dimensions are ordered as HDB Complete elements.

- 420 System element standard design (dark grey)
→ for example, element length $L = 420$ mm (see order example)
- # System element available on request (light grey)
→ element length on request
- Not available

- ① Assembly bar clips are ordered separately (see page 29).
- ② Other stud heights on request.

Order example

HDB - 16 / 205 - 3 / 420

Type _____
 Stud diameter d_A [mm] (a) _____
 Stud height h_A [mm] (b) _____
 Number of studs per element (c) _____
 Element length L (set or required value) _____

HALFEN HDB-S SHEAR RAIL — SHEAR REINFORCEMENT

Simplified Calculation

Simplified calculation with a FE-calculation program and selection of the HDB-S Shear rails

Reinforced concrete slabs are currently mainly calculated with finite-elements based calculation programs. The following describes a simple method to determine the required shear stress reinforcement based on FE calculations. This avoids the complexity required with a separate calculation of HDB-S Shear stress reinforcement.

Example:
 Single axis spanned reinforced concrete slab $L = 6\text{ m}$;
 concrete C20/25; $h = 20\text{ cm}$; $d = 16\text{ cm}$; $\rho_l = 0.5\%$;
 transverse reinforcement 50%; live load $q_k = 10\text{ kN/m}^2$;
 the program automatically takes the dead-load into account.
 A wall in the middle of the slab is assumed as a linear load:
 $w_k = 50\text{ kN/m}$
 Concrete cover $c_{nom} = 2.5\text{ cm}$

1. Calculating a reinforced concrete slab using FE-software

→ it is recommended to use a variable inclination of the compression strut method for shear design

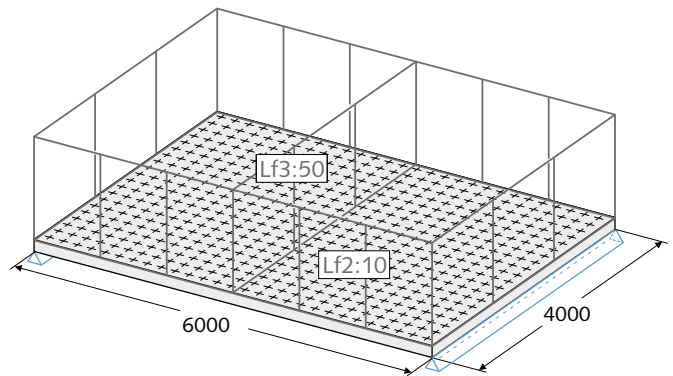

2. Calculating the required shear reinforcement using FE-calculation software

→ checking the maximum load capacity ($V_{Rd,max} > V_{Ed}$)
 → calculating the concrete load capacity ($V_{Rd,c}$)
 → required shear reinforcement output

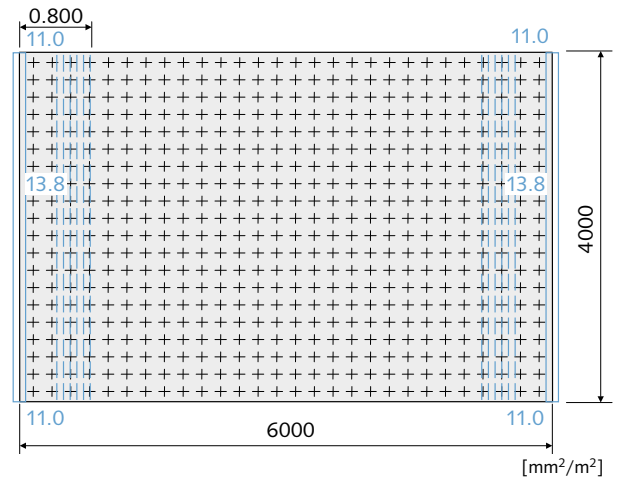

3. Distribution in plan

→ dividing the plan into identical amounts of shear reinforcement
 → calculating the dimension of each individual area

The result from this example was two areas with a length of 80 cm and a width of 400 cm

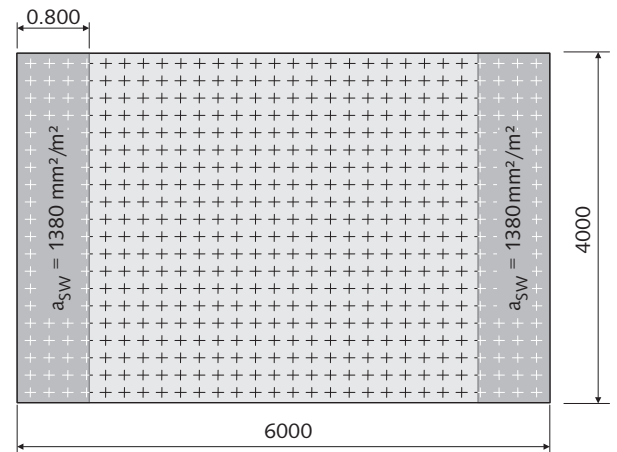

HALFEN HDB-S SHEAR RAIL — SHEAR REINFORCEMENT

Simplified Calculation

Simplified calculation with a FE-calculation program and selection of the HDB-S Shear rails

4. Calculating the allowable crosswise and lengthwise spacing for HDB-S Anchor (see page 24)

- checking the boundary conditions
- allowable anchor spacing in slab span direction ($s_{L,HDB-S}$)
- allowable anchor spacing transverse to slab span direction ($s_{Q,HDB-S}$)

5. Calculating the anchor height and defining a grid for the HDB-S Anchor (further notes on page 24)

- distribution of anchors according to the approved anchor spacing
- if possible consider spacings with HDB Anchors available from standard stock (see page 21)

6. Defining the required anchor diameter (see table on page 20)

- calculating the required anchor diameters using the selected anchor spacings and the required reinforcement cross-section

7. Establishing the number of elements and compiling an item list

- calculating the required number of element rows
- dividing the anchor row into 2 and 3 anchor-elements
- checking present edge spacing against the minimal required edge spacing (see page 24)
- understanding the element description (see page 28)

Data from the FE-Program:

- maximum load capacity $V_{Rd,max} = 440 \text{ kN/m}$
- concrete load capacity $V_{Rd,c} = 69.5 \text{ kN/m}$
- load $V_{Ed} = 96.0 \text{ kN/m}$
- utilisation factor $V_{Ed}/V_{Rd,max} = 0.22$

Required boundary conditions

- slab thickness $h = 20 \text{ cm} \geq 16 \text{ cm} (h_{min})$

Maximal anchor spacing (see page 24):

- max. lengthwise spacing $s_{L,HDB-S} = 0.8 h = 16 \text{ cm}$
- max. crosswise spacing $s_{Q,HDB-S} = 1.5 h = 30 \text{ cm}$

Calculating anchor height:

- anchor height $h_A = h - 2 \times c_{nom} = 200 - 2 \times 25 = 150 \text{ mm}$
selected: $h_A = 155 \text{ mm}$

Selected anchor spacing:

- lengthwise $s_{L,HDB-S} = 16 \text{ cm} \approx 5 \text{ anchors/elements row}$
- crosswise $s_{Q,HDB-S} = 30 \text{ cm} \approx 3.3 \text{ elements/m}$

Given:

- required shear reinforcement $a_{sw,req} = 13.8 \text{ cm}^2/\text{m}^2$
 - cross-section per element row $a_{sw,req} = 13.8/3.3 = 4.2 \text{ cm}^2/\text{m}$
- selected anchor diameter (see table on page 20)
- anchor diameter $d_A = 10 \text{ mm}$
 - present shear reinforcement: $a_{sw,actual} = 4.95 \times 3.3 = 16.3 \text{ cm}^2/\text{m}^2$

Verification

- $a_{sw,actual} > a_{sw,req}$

Distribution of elements:

- number of anchor rows $m = 400/30 = 13 \text{ rows}$
- no. of anchor in each row $n = 80/16 = 5 \text{ anchors}$
- configuration: 13 elements rows, each with one 2 stud and one 3 stud HDB-S element

Checking the present edge spacing (see page 24)

- present edge spacing $\rightarrow a_{Q,HDB-S} = (400 - 12 \times 30)/2$
 $\rightarrow \text{present } a_{Q,HDB-S} = 20.0 \text{ cm}$
 $> \min a_{Q,HDB-S} = 12.0 \text{ cm}$

Element description:

- HDB-S - $d_A / h_A - n / L_{Ges}$ ($L_{Ges} = n \times s_{L,HDB-S}$)

Parts list and element description:

- $2 \times 13 \times \text{HDB-S-10/155-2/320} (80 / 160 / 80)$
- $2 \times 13 \times \text{HDB-S-10/155-3/480} (80 / 160 / 160 / 80)$

HALFEN HDB-S SHEAR RAIL — SHEAR REINFORCEMENT

Installation Notes

Allowable anchor spacings

The maximal anchor spacing, longitudinal and transverse, depends on the thickness of the slab and the loads in the following table. When absolute and relative values are provided the lower of the two is decisive.

The first anchor in a row is placed at a distance of $s_{L,HDB-S}$ from the centre line of the load. In addition, the transverse spacing also depends on the transverse reinforcement.

With transverse reinforcement values between 20% and 50%, the allowable transverse spaces may also be linearly interpolated. In single-axis-span slabs a transverse reinforcement of at least 20% of the main reinforcement is required for tension forces and transverse bending moments.

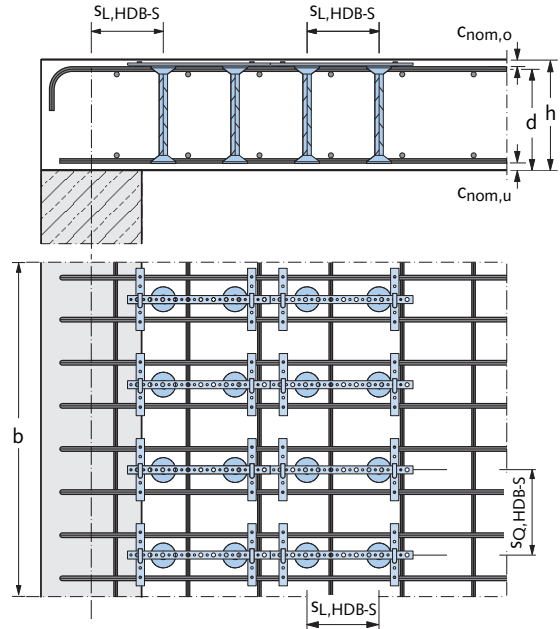

Shear load force	Slab thickness h [cm]	Maximum anchor spacing in support direction $s_{L,HDB-S}^*$	Maximum anchor spacing in transverse direction $s_{Q,HDB-S}^*$ transverse reinforcement	
			20%	50%
$V_{Ed} \leq 0.3 V_{Rd,max}$	$h \leq 40$	$0.8 h$	$1.0 h$	$1.5 h$
	$h > 40$	$0.7 h$ or 30 cm	$1.0 h$ or 80 cm	$1.0 h$ or 80 cm
$0.3 V_{Rd,max} < V_{Ed} < 0.6 V_{Rd,max}$	$h \leq 40$	$0.6 h$	$1.0 h$	$1.5 h$
	$h > 40$	$0.5 h$ or 30 cm	$1.0 h$ or 60 cm	$1.0 h$ or 60 cm
$V_{Ed} \geq 0.6 V_{Rd,max}$	$h \leq 40$	$0.25 h$	$1.0 h$	$1.5 h$
	$h > 40$	$0.25 h$ or 20 cm	$1.0 h$ or 60 cm	$1.0 h$ or 60 cm

* The anchor spacings apply for concrete grades $\leq C45/55$.

See National Technical Approval No. Z-15.1-249 and Z-15.1-270 for anchor spacing for concrete grades C50/60.

Installation notes

Reinforcement stirrups must be placed in all free edges of slabs to secure and hold the concrete cover. At least one longitudinal reinforcement bar must be placed at anchor head height

between the free component edges and the HDB-S Anchor. The minimal edge spacing $a_{Q,HDB-S}$ and minimal slab thickness for each anchor diameter can be found in the following table.

Anchor diameter d_A [mm]	Minimal slab thickness h [cm]	Minimal anchor space to free edges depending on the concrete strength class $a_{Q,HDB-S}$ [cm]				
		C 20/25	C 30/37	C 35/45	C 45/55	C 50/60
10	16*	12	11	9	8	8
12	16*	15	13	11	10	10
14	16*	17	15	13	12	12
16	16	20	17	15	13	13
20	25	25	21	19	17	17
25	39.5	31	26	23	21	21

*minimal slab thickness according to the German National Annex NA(D) for EN 1992-1-1:2011-01

HALFEN HDB / HDB-S SHEAR RAIL – PUNCHING SHEAR / SHEAR REINFORCEMENT

Calculation Software

Our Calculation program is an especially easy-to-use tool to help in punching shear and shear reinforcement planning.

The program was compiled based on current approvals and expert reports. The program helps to determine the optimal punching and shear reinforcement for the required slab geometry and loads. A selection of calculation methods based on national and international standards and approvals are integrated in the software.



The calculation method in the report is based on EN 1992-1-1:2011-01 and the relevant National German Annex NA(D). This ensures unproblematic application in Germany compliant with the current generation of European standards. The expert report forms the basis for EN 1992-1-1 and the modified National technical Approval for HDB-S (Z-15.1-249 and Z-15.1-270) for the relevant National German Annex NA(D).

Therefore, the program is suitable for HDB Shear rails in punching shear reinforcement applications and also in shear stress reinforcement applications.

For calculation of ground slabs or foundations, HDB-Z a punching shear reinforcement which is especially designed for this application can be selected. Basis for this design is the National Technical Approval No. Z-15.1-330. The software allows choosing HDB-Z elements from 10 up to 16 mm diameter manually or it generates automatically optimized HDB-Z cross sections. HALFEN HDB-Z Elements allow a substantial reduction in the thickness of foundations.

Project administration

Any number of different positions can be calculated within a project and stored in the project data-file; this data is immediately accessible to the user for further editing.

The data has to be confirmed after every calculation by selecting the 'Accept' button; otherwise previous data will be overwritten by subsequent input. An administration window enables quick navigation through the project data.

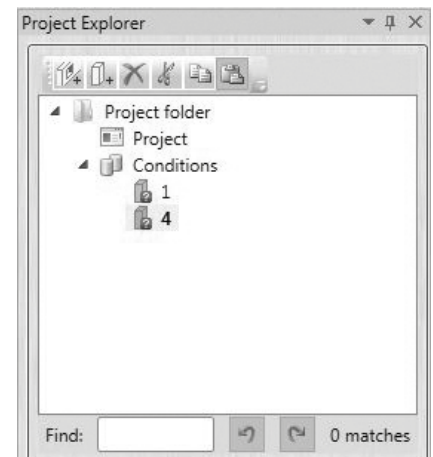

The calculation software allows calculation of shear loads based on an expert report published by Prof. Dr. Hegger/ Dr. Roeser, H+P Ingenieure, Aachen^①.

^① Hegger, J.; Roeser, W.: Calculation of HDB-S-Anchors according to Eurocode 2 based on the National Annex for Germany. Expert report H+P Ingenieure, Aachen 2011.

HALFEN PUNCHING SHEAR / SHEAR REINFORCEMENT Calculation Software

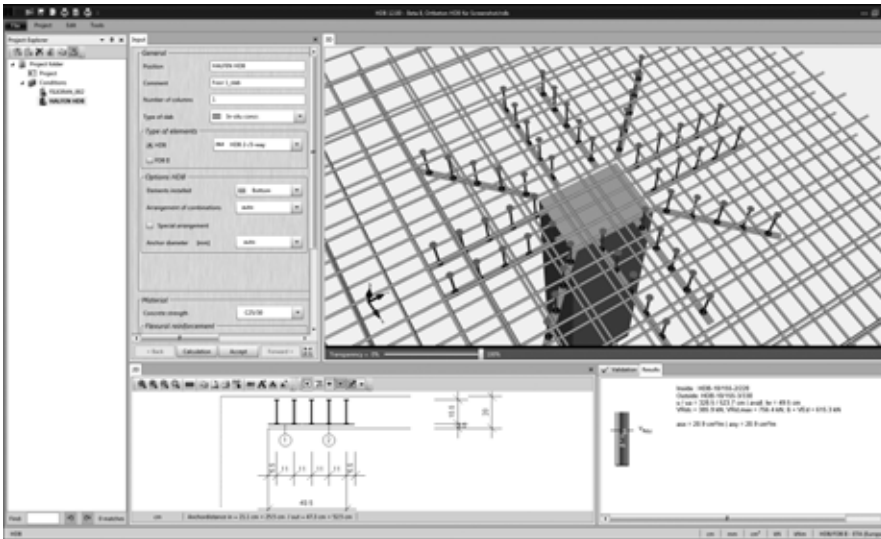

Punching shear calculation

Punching shear calculation is possible for floor slabs (semi-precast and on-site cast concrete slabs) foundations and footings.

System-elements with 2 or 3 anchors or complete elements can be selected for HDB Punching shear rails. All elements can be installed from above or from below. Anchor diameters (10, 12, 14, 16, 20 or 25 mm)

can be selected automatically and optimally by the software program or user specified diameters can be entered manually. This also applies when selecting combinations of punching shear elements.

In standard mode the program automatically optimizes the number of HDB Elements. It is possible to freely select the number of elements manually to individual requirements in compliance with the approval.

According to the approval, two methods are available to determine the load increase factor:

- constant load factor according to EN 1992-1-1,
- a more precise method using a plastic shear stress distribution according to EN 1992-1-1:2011-01.

Openings

Openings close to the punching shear region can be easily considered by defining their centre of gravity and dimensions.

Openings				
	dx=did [cm]	dy [cm]	xs [cm]	ys [cm]
1	20	20	40	60

Shear stress calculation

The program verifies the shear loads for end or intermediate supports in concrete slabs. On the basis of the provided data for geometry, loads and the shear forces at the supports the program calculates the respective shear stresses. The shear force is subsequently verified in accordance with the expert report by Hegger/Roeser and if required, shear reinforcement (HDB-S Shear rails) are selected.

Alternatively the design shear force or the required shear reinforcement can be entered directly into the program. If the slab has already been calculated with a FE-Program and the required shear stress reinforcement per square-meter is known, then this information can be entered and directly converted into HDB-S Shear stress reinforcement using the HDB-Program. If the design shear force is known, then the HDB-Program can select the required HDB-S Shear stress reinforcement in accordance with the Hegger/Roeser expert report.

The HDB-software calculates "infinite" expanded floor slabs as well as discrete slab strips. In addition, it is also possible to enter any number of contributory floor slabs. These can either be estimated or be selected more realistically using secondary sources, for example. Journal no. 240 published by the German Committee for Structural Concrete (DAFStb, Deutscher Ausschuss für Stahlbeton). The shear stress resistance near interior and exterior walls in foundation slabs can also be verified. The same calculation options are basically available as for floor slabs.

HALFEN PUNCHING SHEAR / SHEAR REINFORCEMENT Calculation Software

Edit window

The edit window, available in 2D or 3D, is used to display the system geometry. The 2D modus is used to edit or delete shear rails. Any present openings can also be moved.

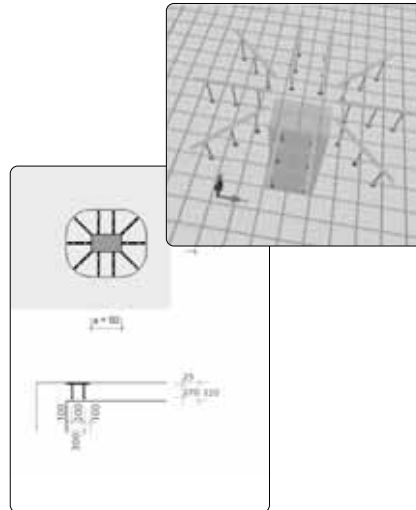

Internet download

The current version of the calculation program is available for free download on the internet at www.halfen.com.

If the option is selected, the HDB-Software will automatically check—every time the program is started— if a newer version of the program is available.

System requirements for the HDB Design software:

- Windows 10, 8.x, Windows 7
- Microsoft .NET Framework 4.6

Plans, print-out; DXF

DXF file data can be created for each calculated position with a plan view, section and optional dimensioning information. This data can then be integrated into reinforcement plans.

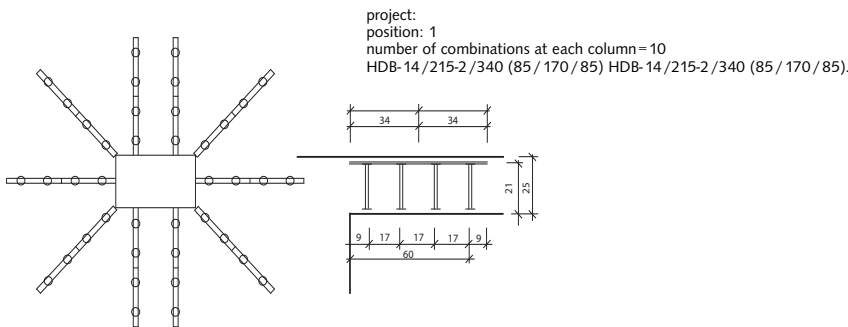

Printouts

After calculating the punching shear or shear stress reinforcement the HDB Calculation program creates a calculation report, the required plans, parts lists and if requested, an order list.

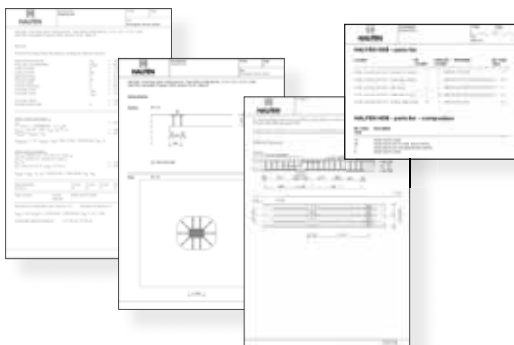

HALFEN PUNCHING SHEAR / SHEAR REINFORCEMENT

Type Selection, Order Information, Accessories

Order description HDB

Dimensioning of HDB Shear rails as punching shear and shear force reinforcement

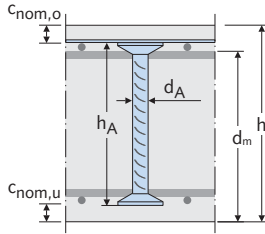

HDB System elements

2 or 3 studs

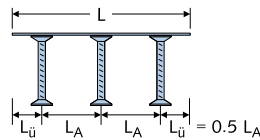

HDB - 16 / 205 - 3 / 420
 type stud dimensions d_A / h_A number of studs element length L

HDB Complete elements

2 - 10 studs

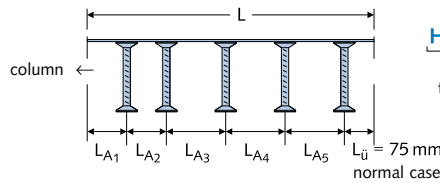

HDB - 16 / 205 - 5 / 725 (100 / 100 / 150 / 150 / 150 / 75)
 type stud dimensions d_A / h_A number of studs element length L stud spacings $L_{A1}/L_{A2}/\dots/L_{An}$ end spacing $L_{ü}$

HDB-F Elements

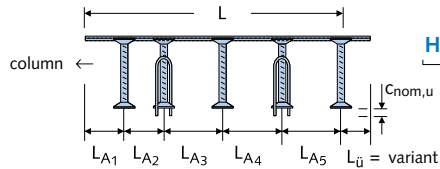

HDB - F - 16 / 205 - 5 / 650 (100/100/150/150/150) $c_{nom,u} = 2.5 \text{ cm}$
 type stud dimensions d_A / h_A number of studs element length L stud spacings $L_{A1}/L_{A2}/\dots/L_{An}$ dimension $c_{nom,u}$ for spacer

Installation accessories

Clip bars

Optional; not always required.
 To facilitate top installation, we generally recommend calculating an average of 1.5 clip bars for HDB Elements (see page 29).

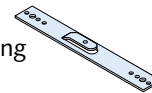

HDB CLIP BAR
 type

Spacer

For installation from below i.e. with HDB Complete elements.
 The dimension $c_{nom,u}$ refers to the the concrete cover.
 Type selection (see page 29).



HDB ABST - 30
 type dimension $c_{nom,u}$

HALFEN PUNCHING SHEAR / SHEAR REINFORCEMENT

Accessories

Installation of HDB/HDB-S to reinforcement

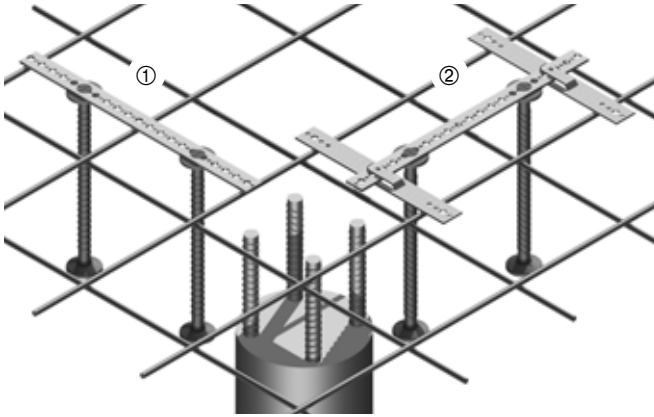

We generally recommend calculating an average of 1.5 clip bars for the HDB Elements

Note:

To avoid clip bars overlapping, they can be attached anywhere on the spacer bar.

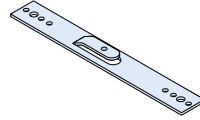

HDB Clip bars

Clip bars are not included in the scope of delivery.

Please order separately.

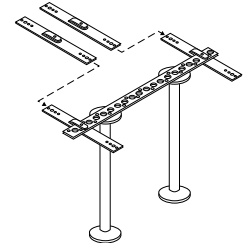

Application example

① Installed at right angles to the top reinforcement: **without clip bars**, shear rails (spacer bars) are installed perpendicular to the top reinforcement.

② Installed parallel to the top reinforcement: **(with HDB Clip bars)**

Designation	Dimensions [mm]	Order no. 0066.020-
HDB Clip bar	-35/3×275	00001

Spacer HDB ABST for installation from below

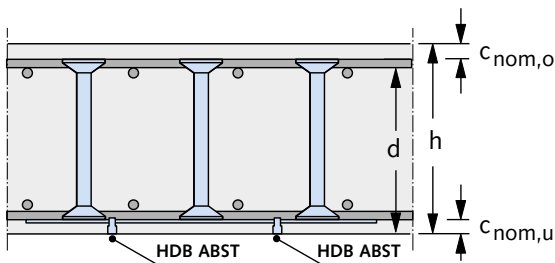

③ State $c_{nom,u}$ when ordering

Recommendation: Order 2 spacers per HDB Element for installation from below.

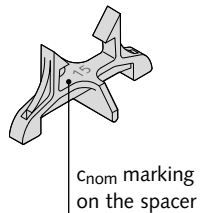
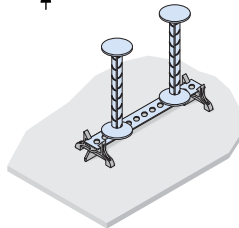

Spacer type HDB ABST

Concrete cover $c_{nom,o}$ and $c_{nom,u}$ according to EN 1992-1-1:2011-01 and the respective national annex; Material **KS** = plastic

Designation Type - dimension $c_{nom,u}$ [mm] ③	Order no. 0066.010-
HDB ABST - 15/20	00001
HDB ABST - 25	00002
HDB ABST - 30	00003
HDB ABST - 35	00004
HDB ABST - 40	00005

Storage and transport

Note:

When storing and transporting semi-precast slabs the **punching shear reinforcement elements protrude** above the lattice girders. Use appropriate spacer heights to support the semi-precast slabs.

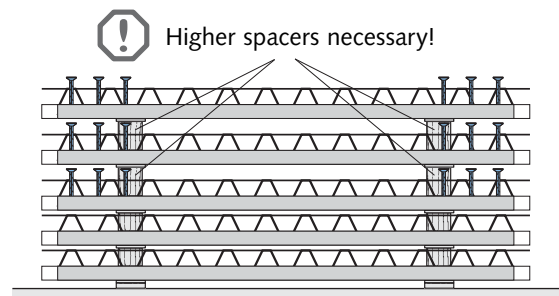

HALFEN HDB-F SHEAR RAIL – PUNCHING SHEAR REINFORCEMENT

Punching Shear Reinforcement in Element Slabs

HALFEN HDB Punching shear reinforcement – Application in element slabs

HDB Punching shear reinforcement in element slabs: Installation

In element slabs the HDB Punching shear reinforcement has to be assembled from below. HDB ABST Spacers are to be used.

This applies to both HDB System elements and HDB Complete elements.

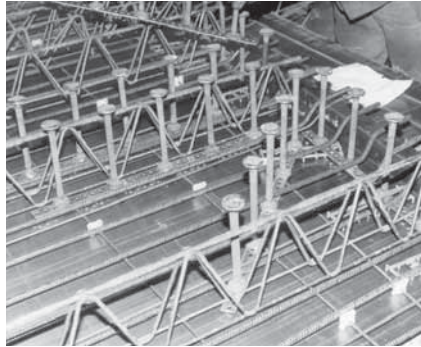
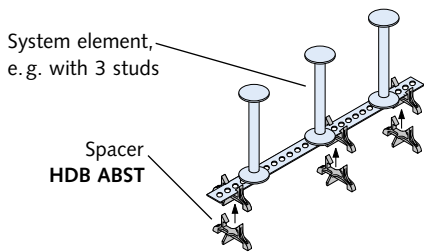

Precast: Installing flexural reinforcement and HDB Punching shear elements in precast concrete element production. Additional lattice girder reinforcement is generally required to ensure a good bond.



On-site: Semi-precast slab with HDB elements before pouring the concrete.

HALFEN HDB-F Shear rail – Especially for application in element slabs

The shear rail for efficient installation; ideal for automated production

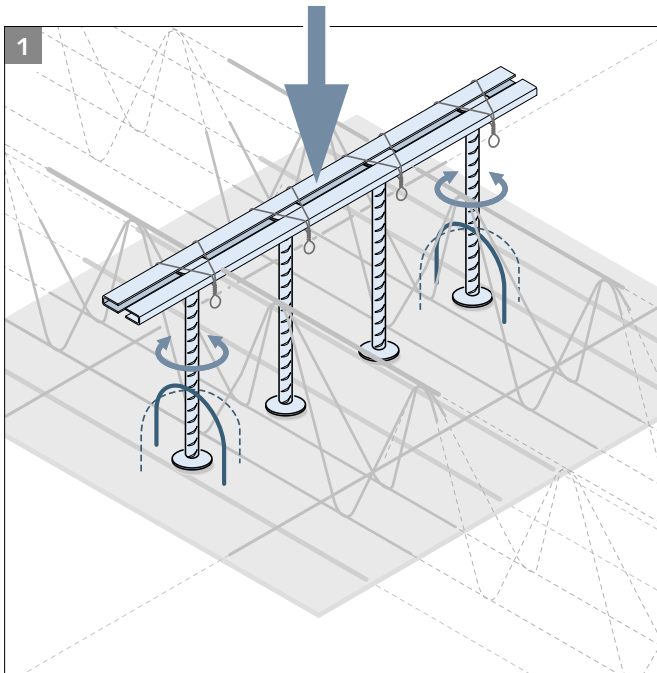

At the precast plant: HALFEN HDB-F Shear rails are installed after the lower reinforcement from above. The double-headed studs can be individually rotated. This allows the spacers to be easily aligned. The removable assembly bar is placed on top of the lattice girders.

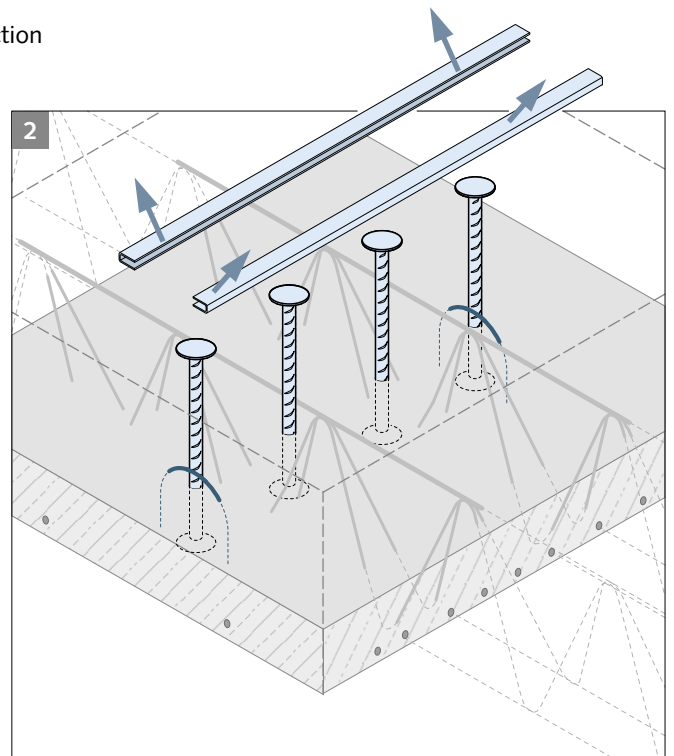

At the construction site: After the concrete has sufficiently hardened, remove the two-piece assembly bar from the HDB-F Stud. The upper reinforcement layer can now be fitted at the construction site.

HALFEN HDB-F SHEAR RAIL – PUNCHING SHEAR REINFORCEMENT

Punching Shear Reinforcement in Element Slabs

HDB-F – Product advantages that count

- › **Production time reduced up to 50%**
Using HALFEN HDB-F Shear rails can reduce factory production times for precast components by up to 50%.
- › **Installation independent from other reinforcement**
The HALFEN HDB-F Shear rails are fitted after the lower reinforcement has been installed. This allows installation of the required lower reinforcement for pre-fabricated slabs including the lattice girders to be completed, hindrance free.
- › **Removable assembly rails**
The double-headed stud heads are connected by two C-shaped sheet steel assembly rails. These are kept securely in position with easily removable tying-wire or non-metallic straps.
- › **Rotatable studs with spacers**
The HDB-F Shear double-headed studs in spacer rail are fixed freely rotatable in the assembly bar. This allows the spacers to be easily inserted between the previously placed precast slab reinforcement. Please state the thickness of the lower concrete cover c_{nom} when ordering.
- › **Ideal for automated plants**
Production times can be reduced by up to 50% significantly increasing plant efficiency.
- › **Complete elements**
HALFEN HDB-F Shear rails are manufactured as complete elements with 2 to 8 anchors. HALFEN HDB-F Shear rails complete elements are easily fitted from above as no upper reinforcement is placed in semi-precast components at the production plant.
- › **Note on design**
The punching shear design is generally the same for cast-on-site concrete slabs and pre-fabricated slabs. However, the shear force transfer in precast slab joints must also be verified according to Eurocode 2, section 6.2.5, and the appropriate National Annex: the necessary bonding reinforcement also needs to be verified.



Production of precast elements using HALFEN HDB-F Shear rails

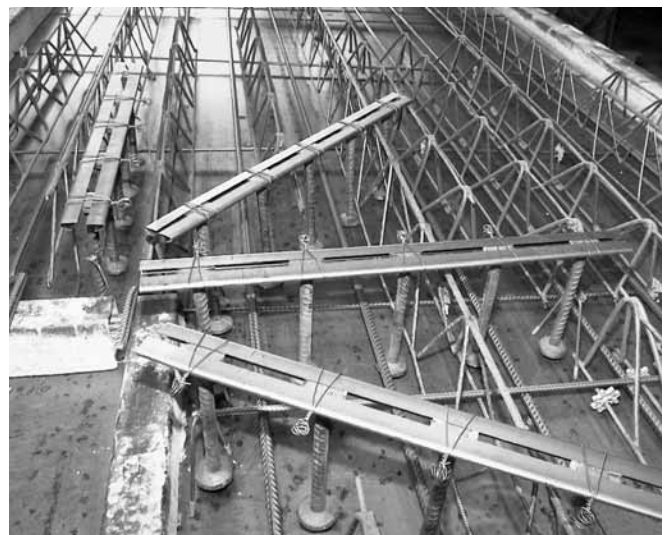

HALFEN HDB-F Shear rails are easy to install

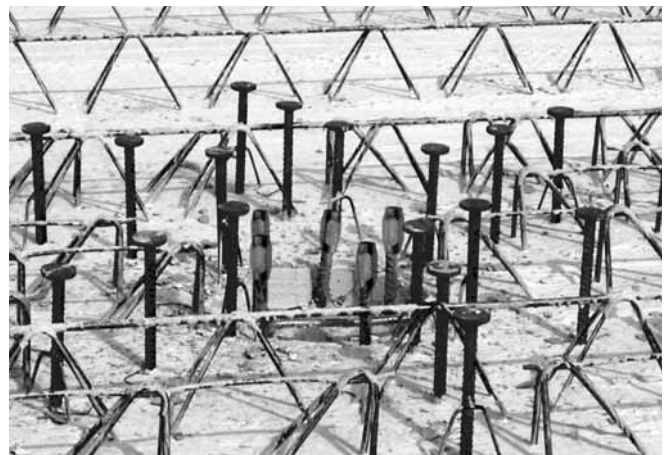

Precast slab with HDB-F Shear rails in place on the construction site. The assembly bars have been removed; the top reinforcement can now be installed without any obstructing top bars.

HALFEN HDB PUNCHING SHEAR REINFORCEMENT

HDB-Z Punching Shear Reinforcement for Slab and Pad Foundations

Advantages of HDB-Z Elements

A solid foundation: HALFEN HDB-Z punching shear reinforcement

The new HALFEN HDB-Z Punching shear reinforcement now allows an even more efficient design of foundation slabs and pad foundations against punching failure. Due to the specially designed shape, multi low-slip anchorage points in the concrete, a component reinforced with HDB-Z has a significant increase in load-bearing capacity to prevent punching shear failure.

Maximal safety

- › European technical assessment ETA-22/0360 and DIBt National Technical Approval No. Z-15.1-330
- › HDB-Z with 10–16 mm anchor diameter
- › approved for slabs and pad foundations with a height of 230 mm or more
- › for normal concrete, strength class C12/15 up to C50/60
- › for predominantly static, non-predominantly static and dynamic loads

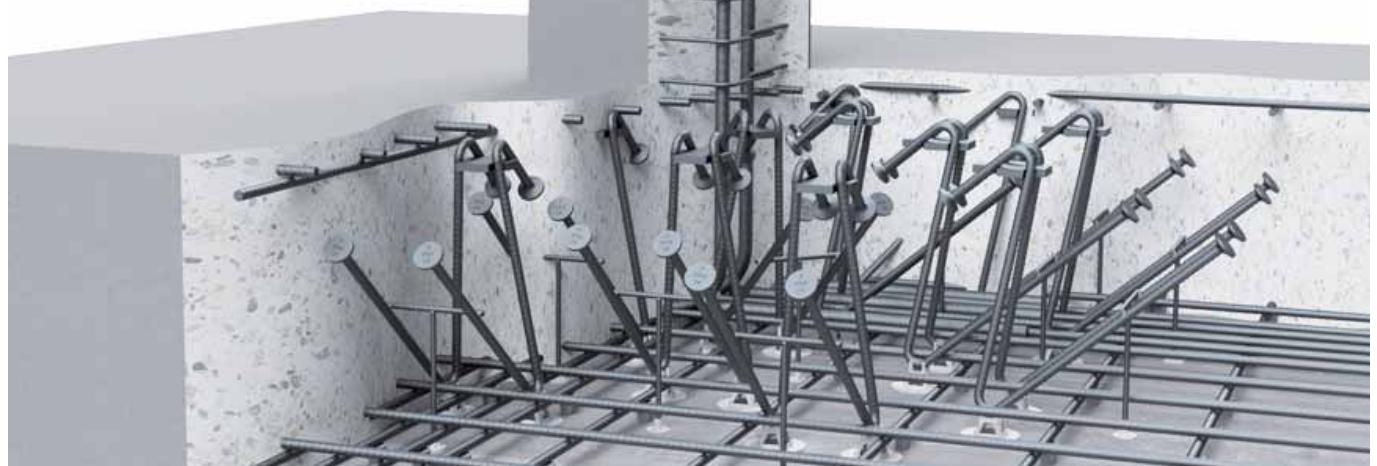

The tried and tested HDB Software is available for calculation of HDB-Z for foundation slabs and pad foundations. HDB-Zs with a diameter of 10-16 mm can be automatically

and optimally calculated by the software or can be freely selected. The current version of the HDB software is available as a free download at www.halfen.com.

Economical

- Reduction of the height of In-situ concrete and precast foundations.
- › reduced expenditure for groundwater drainage
 - › time and cost savings for installation and compaction of the concrete
 - › less or no formwork required, e.g. for reinforced foundations or punching areas
 - › reduction of the constraining loads and the minimum reinforcement etc.

Reliability and quality

- › easy installation between the reinforcement layers
- › stays firmly fixed in the formwork prior to pouring the concrete
- › as a ISO 9001 certified company with 20 years of experience in the production of HALFEN HDB Shear rails, we supply first-class products, the quality of which is constantly monitored by internal and third party inspection bodies.

HALFEN HDB PUNCHING SHEAR REINFORCEMENT

HDB-Z Punching Shear Reinforcement for Slab and Pad Foundations

The situation: Foundation slabs or pad foundations with rising columns

Foundation components; foundation slabs and pad foundations are often subjected to punching shear by columns in the same way as other ceiling/roof flat slabs. High loads from ascending levels must be safely transferred into the subsoil through these components.

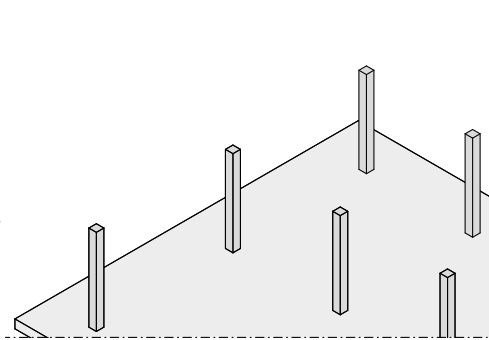

Foundation slab

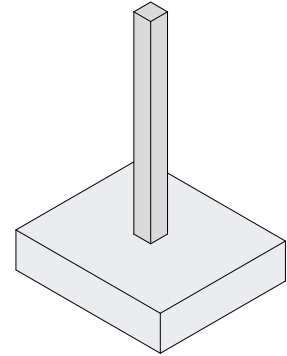

Pad foundations

The problem: Punching failure in the foundation component around columns

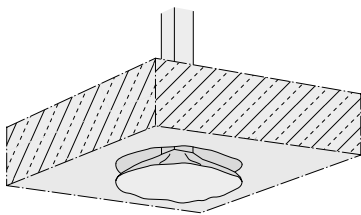

High concentrated loads, i.e. point loads in the column area of floor slabs or pad foundations, lead to increased stresses.

This is similar to the increased effect of punching shear in flat concrete slabs. As with flat slabs, the use of additional reinforcement elements becomes necessary if the concrete load-bearing capacity $V_{Rd,c}$ is exceeded. The load-bearing capacity can be increased by various measures, but this often leads to uneconomical dimensions or costly reinforcement work.

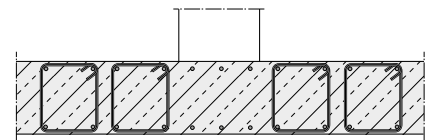

- **Uneconomical**
Complex and costly installation of stirrup reinforcement

The solution: HALFEN HDB-Z Punching shear elements

The curved HDB Double head anchors produce the characteristic shape of the HDB-Z elements. The tried and tested head shape at the rod element ends and the anchor plate between the Z-shaped anchors ensure low-slip anchoring in the concrete. In addition, the shear crack is traversed several

times by a HDB-Z element so that the opposite crack edge zones are effectively restrained. The resistances in the components have been significantly increased compared to conventional solutions. The 'Z' shape has proved to be an effective measure to limit shear cracks.

Compared to conventional solutions, e.g. stirrup reinforcement, the maximum concrete load-bearing capacity in the concrete compression strut ($V_{Rd,max}$) can be increased by up to 55% with the same design of the foundation component.

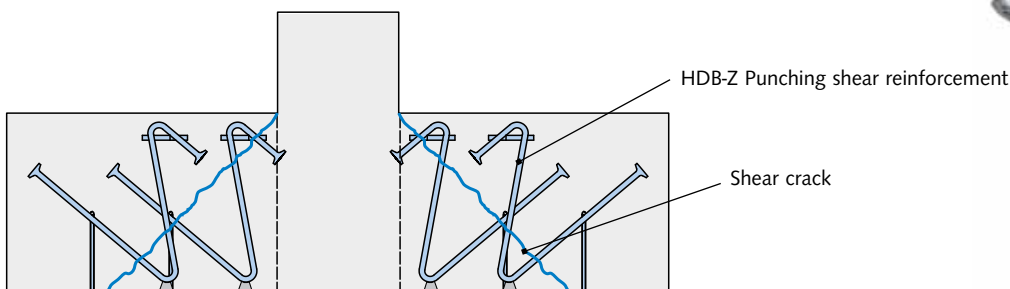

HALFEN HDB PUNCHING SHEAR REINFORCEMENT

HDB-Z Punching Shear Reinforcement for Slab and Pad Foundations

Order example

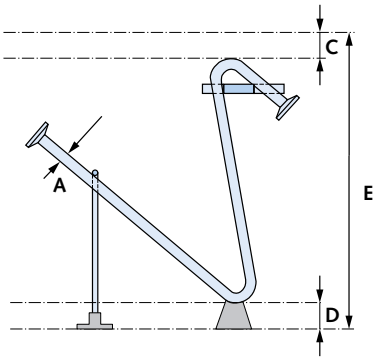

Order example: Dimensions in [mm]

	HDB-Z - 12 - 400 - 30 - 30
Type	_____
Anchor diameter \varnothing (A)	_____
Foundation height h_{found} (E)	_____
Concrete cover, top $c_{\text{nom,o}}$ (C)	_____
Concrete cover, bottom $c_{\text{nom,u}}$ (D)	_____

Design concept

1. Verification method

analogue to the punching shear verification according to DIN EN 1992-1-1(EC2):

$$\text{Verification method: } V_{Rd} \geq V_{Ed,red} \cdot \beta$$

load increase factor β in accordance with DIN EN 1992-1-1 + NA (D) constant load increase factor:

- $\beta = 1.10$ for internal columns (NA(D))
- $\beta = 1.15$ for internal columns (EN 1992-1-1)
- $\beta = 1.40$ for edge columns
- $\beta = 1.50$ for corner columns

2. Verification of punching shear without reinforcement

(analogue to the HDB design concept according to DIN EN 1992-1-1 for building components with ground contact)

$$V_{Rd,c}(\text{EC2}) = \frac{C_{Rk,c}}{\gamma_c} \cdot k \cdot (100 \cdot \rho_l \cdot f_{ck})^{\frac{1}{3}} \cdot 2 \cdot \frac{u_{crit} \cdot d_m^2}{a_{crit}}$$

- k = Scale factor analogous to the design concept for flat slab elements
- $C_{Rk,c}$ = 0.15
- γ_c = 1.5
- ρ_l = Ratio of longitudinal reinforcement analogous to the design concept for flat slab
- f_{ck} = characteristic concrete compressive strength
- d_m = average static height
- a_{crit} = Distance from column edge to the critical perimeter
- $V_{Rd,c}$ = $\max(V_{Rd,c}; V_{min}) \cdot u_{crit} \cdot d_m$
- ΔV_{Ed} = assumed ground pressure according to DIN EN 1992-1-1
- u_{crit} = critical perimeter (see page 12)

$$\text{Verification: } V_{Rd,c} + \Delta V_{Ed} < V_{Ed} \cdot \beta$$

3. Verification of punching shear capability with HDB-Z Reinforcement elements according to ETA-22/0360 and Z-15.1-330

$$V_{Rd,c,HDB-Z} = \frac{C_{Rk,c}}{\gamma_c} \cdot k \cdot (100 \cdot \rho_l)^{\frac{1}{3}} \cdot 0.57 \cdot f_{ck}^{\frac{1}{2}} \cdot \frac{2 \cdot d_m^2}{a_{crit}} \cdot u_{crit} > V_{min}$$

3.1 Calculating the steel load capacity:

(Calculating the the load capacity factor of the HDB-Z elements in the first rows)

$$V_{Rd,s} = (3.2 \cdot n_1 + 1.6 \cdot n_2) \cdot \varnothing_{sw}^2 \cdot f_{ywd}$$

- n_1 = no. of elements in the first row
- n_2 = no. of elements in the second row
- \varnothing_{sw} = Diameter of the punching shear reinforcement
- f_{ywd} = Yield strength of the punching shear reinforcement = 435N/mm²

3.2 Total load capacity of the HDB-Z Elements

When using HDB-Z elements, it is permissible to assume 90% of concrete load-bearing capacity with the steel load-bearing capacity. The total load-bearing capacity is determined by the following equation:

$$\text{Verification: } V_{Rd,cs} = 0.9 \cdot V_{Rd,c,HDB-Z} + V_{Rd,s} + \beta \cdot \Delta V_{Ed} \geq \beta \cdot V_{Ed}$$

HALFEN HDB PUNCHING SHEAR REINFORCEMENT

HDB-Z Punching Shear Reinforcement for Slab and Pad Foundations

Design concept

4. Verification of the concrete load bearing capacity in the outer control perimeter u_{out}

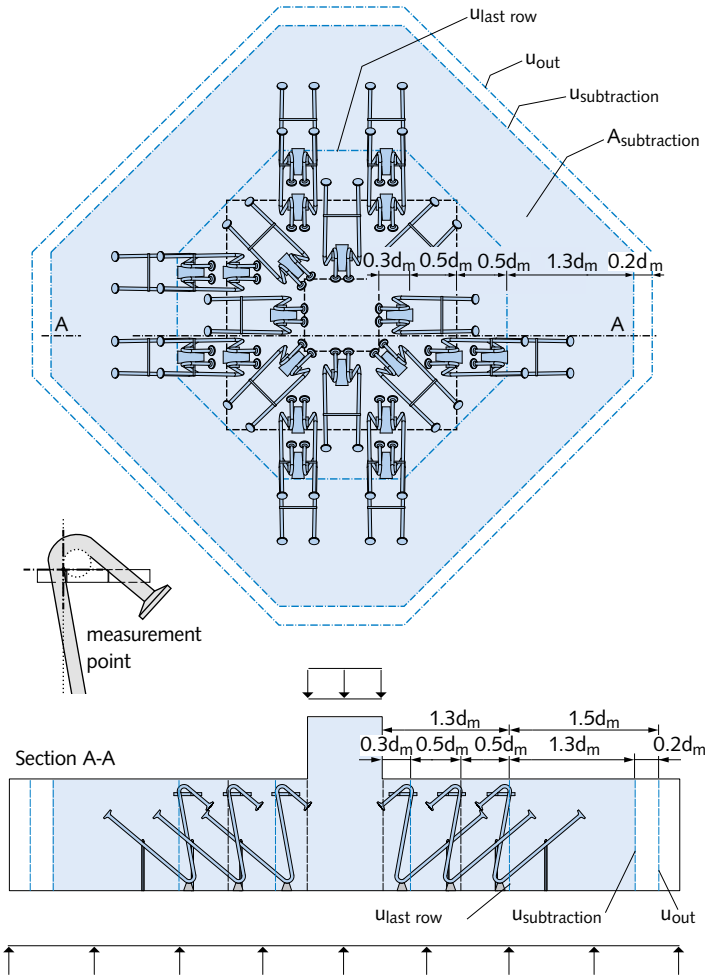

$$V_{Rd,c,out} = \max \{ V_{Rd,c}; V_{min} \}$$

$$\text{Verification: } V_{Rd,c,out} + \beta \cdot \Delta V_{Ed} \geq \beta \cdot V_{Ed}$$

5. Maximum load capacity of compression strut

$$V_{Rd,max} = \alpha_{max} \cdot V_{Rd,c,HDB-Z}$$

$$\alpha_{max} = 2.35 \text{ f\"ur } d_m \leq 1.0 \text{ m}$$

$$\alpha_{max} = 1.50 \text{ f\"ur } d_m > 1.6 \text{ m;}$$

Intermediate values may be interpolated

$$\text{Verification: } V_{Rd,max} + \beta \cdot \Delta V_{Ed} \geq \beta \cdot V_{Ed}$$

6. Minimum constructive reinforcement

Minimum reinforcement must be ensured in accordance with ETA-22/0360 and Z-15.1-330. This is calculated for the critical perimeter $u_{0,5d_m}$ and must be installed within $1.0 \cdot d_m$ distance thereof.

$$A_{sw,min,1,0d} = \frac{0.08}{1.5} \cdot \frac{\sqrt{f_{ck}}}{f_{yk}} \cdot u_{0,5d_m} \cdot d_m$$

$u_{0,5d_m}$ = Critical perimeter ($0.5d_m$ from the column edge)

f_{yk} = characteristic value of the reinforcing steel's yield strength (HDB-Z Elements) = 500 N/mm^2

7. Layout of the HDB-Z Elements

The layout of the elements in plan must be according to the illustrated spacings in the shear punching area:

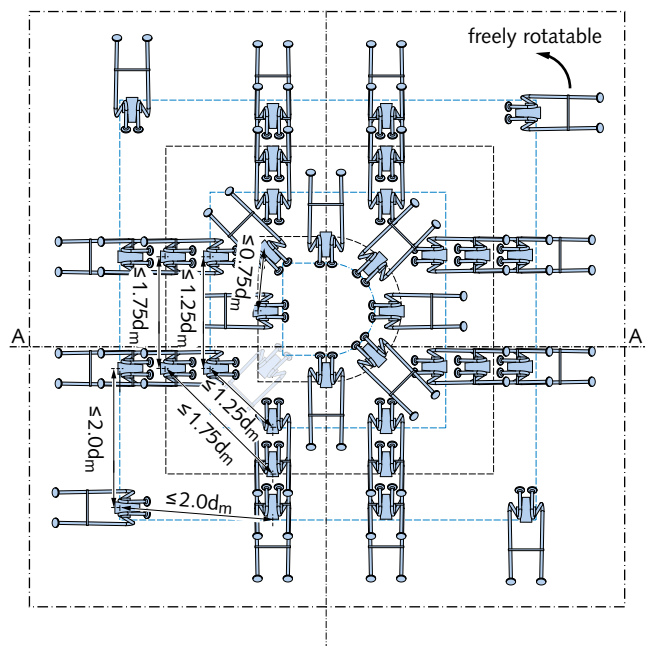

Horizontal spacing between the elements:

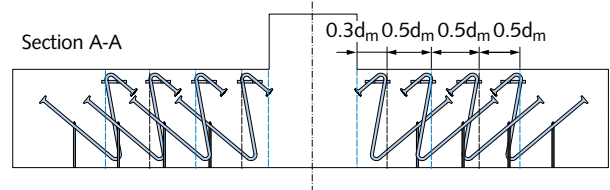

HALFEN PUNCHING SHEAR / SHEAR REINFORCEMENT

Tender Specification

HDB Punching shear reinforcement

HALFEN HDB Shear rail (System element) - $d_A / h_A - n / L$

HALFEN HDB Shear rail as punching shear reinforcement in pad foundations or foundation slabs according to European Technical Assessment ETA-12/0454; in ribbed or smooth reinforcement steel B500, to strengthen shear punch critical areas in flat concrete floor slabs or foundation slabs for non-predominantly static and predominantly static loads.

Type HDB (System element) - $d_A / h_A - n / L$ with

stud diameter	$d_A =$ [mm]
stud height	$h_A =$ [mm]
number of studs	$n =$ [studs / element]
length of shear rail	$L =$ [mm]

or similar, deliver and install using clamps and spacers (accessories) according to the manufacturer's instructions.

Note: refer to the table on page 21 for sizes of available system elements.

HDB-S Shear reinforcement

HALFEN HDB-S Shear rail - $d_A / h_A - n / L$ (Stud spacing)

HALFEN HDB-S Shear rail as shear reinforcement in reinforced concrete slabs or beams according to the National Technical Approval No. Z-15.1-249 and Z-15.1-270, in ribbed or smooth reinforcement steel B 500, to strengthen the shear punch critical areas in beams or slabs for non-predominantly static and predominantly static loads.

Type HDB-S - $d_A / h_A - n / L (L_{A1} / L_{A2} / \dots / L_{An} / L_{\ddot{u}})$ with

stud diameter	$d_A =$ [mm]
stud height	$h_A =$ [mm]
number of studs	$n =$ [studs/element]
length of shear rail	$L =$ [mm]
stud spacings	$L (L_{A1} / L_{A2} / \dots / L_{An} / L_{\ddot{u}})$ = [mm]

or similar, deliver and install using clip bars and spacers (accessories) according to the manufacturer's instructions.

HDB-Z Punching shear reinforcement for foundations

HDB-Z - $\phi - h_{\text{found}} - c_{\text{nom,o}} - c_{\text{nom,u}}$:

HALFEN Punching shear reinforcement type HDB-Z used around columns in concrete floor or foundation slabs, according to European Technical Assessment ETA-22/0360 and National Technical Approval No. Z-15.1-330, in ribbed reinforcement steel B 500, to strengthen shear punch critical areas in foundation slabs or pad foundations for non-predominantly static and predominantly static loads.

Type HDB-Z - $\phi - h_{\text{slab}} - c_{\text{nom,o}} - c_{\text{nom,u}}$ with

Anchor diameter $\phi =$	[mm]
Foundation height $h_{\text{found}} =$	[mm]
Concrete cover, top $c_{\text{nom,o}} =$	[mm]
Concrete cover, bottom $c_{\text{nom,u}} =$	[mm]

or similar, deliver and install using appropriate spacers according to the manufacturer's instructions.





Leviat[®]
A CRH COMPANY

Innovative engineered products and construction solutions that allow the industry to build safer, stronger and faster.



Worldwide contacts for Leviat:

Australia

Leviat
98 Kurrajong Avenue,
Mount Druitt, Sydney, NSW 2770
Tel: +61 - 2 8808 3100
Email: info.au@leviat.com

Austria

Leviat
Leonard-Bernstein-Str. 10
Saturn Tower, 1220 Wien
Tel: +43 - 1 - 259 6770
Email: info.at@leviat.com

Belgium

Leviat
Borkelstraat 131
2900 Schoten
Tel: +32 - 3 - 658 07 20
Email: info.be@leviat.com

China

Leviat
Room 601 Tower D, Vantone Centre
No. A6 Chao Yang Men Wai Street
Chaoyang District
Beijing · P.R. China 100020
Tel: +86 - 10 5907 3200
Email: info.cn@leviat.com

Czech Republic

Leviat
Business Center Šafránková
Šafránková 1238/1
155 00 Praha 5
Tel: +420 - 311 - 690 060
Email: info.cz@leviat.com

Finland

Leviat
Vädursgatan 5
412 50 Göteborg / Sweden
Tel: +358 (0)10 6338781
Email: info.fi@leviat.com

France

Leviat
18, rue Goubet
75019 Paris
Tel: +33 - 1 - 44 52 31 00
Email: info.fr@leviat.com

Germany

Leviat
Liebigstrasse 14
40764 Langenfeld
Tel: +49 - 2173 - 970 - 0
Email: info.de@leviat.com

India

Leviat
309, 3rd Floor, Orion Business Park
Ghodbunder Road, Kapurbawdi,
Thane West, Thane,
Maharashtra 400607
Tel: +91 - 22 2589 2032
Email: info.in@leviat.com

Italy

Leviat
Via F.lli Bronzetti 28
24124 Bergamo
Tel: +39 - 035 - 0760711
Email: info.it@leviat.com

Malaysia

Leviat
28 Jalan Anggerik Mokara 31/59
Kota Kemuning, 40460 Shah Alam
Selangor
Tel: +603 - 5122 4182
Email: info.my@leviat.com

Netherlands

Leviat
Oostermaat 3
7623 CS Borne
Tel: +31 - 74 - 267 14 49
Email: info.nl@leviat.com

New Zealand

Leviat
2/19 Nuttall Drive, Hillsborough,
Christchurch 8022
Tel: +64 - 3 376 5205
Email: info.nz@leviat.com

Norway

Leviat
Vestre Svanholmen 5
4313 Sandnes
Tel: +47 - 51 82 34 00
Email: info.no@leviat.com

Philippines

Leviat
2933 Regus, Joy Nostalg,
ADB Avenue
Ortigas Center
Pasig City
Tel: +63 - 2 7957 6381
Email: info.ph@leviat.com

Poland

Leviat
Ul. Obornicka 287
60-691 Poznań
Tel: +48 - 61 - 622 14 14
Email: info.pl@leviat.com

Singapore

Leviat
14 Benoi Crescent
Singapore 629977
Tel: +65 - 6266 6802
Email: info.sg@leviat.com

Spain

Leviat
Polígono Industrial Santa Ana
c/ Ignacio Zuloaga, 20
28522 Rivas-Vaciamadrid
Tel: +34 - 91 632 18 40
Email: info.es@leviat.com

Sweden

Leviat
Vädursgatan 5
412 50 Göteborg
Tel: +46 - 31 - 98 58 00
Email: info.se@leviat.com

Switzerland

Leviat
Hertistrasse 25
8304 Wallisellen
Tel: +41 (0)800 22 66 00
Email: info.ch@leviat.com

United Arab Emirates

Leviat
RA08 TB02, PO Box 17225
JAFZA, Jebel Ali, Dubai
Tel: +971 (0)4 883 4346
Email: info.ae@leviat.com

United Kingdom

Leviat
A1/A2 Portland Close
Houghton Regis LU5 5AW
Tel: +44 - 1582 - 470 300
Email: info.uk@leviat.com

USA / Canada

Leviat
6467 S Falkenburg Road
Riverview, FL 33578
Tel: (800) 423-9140
Email: info.us@leviat.us

For countries not listed

Email: info@leviat.com

Leviat.com

For information on certified management systems and standards see www.ancon.co.uk | www.aschwanden.com | www.halfen.com

Notes regarding this catalogue

© Protected by copyright. The construction applications and details provided in this publication are indicative only. In every case, project working details should be entrusted to appropriately qualified and experienced persons. Whilst every care has been exercised in the preparation of this publication to ensure that any advice, recommendations or information is accurate, no liability or responsibility of any kind is accepted by Leviat for inaccuracies or printing errors. Technical and design changes are reserved. With a policy of continuous product development, Leviat reserves the right to modify product design and specification at any time.



Imagine. Model. Make.

Leviat.com